

Wireless Weekly

Vol. 7. No. 2.

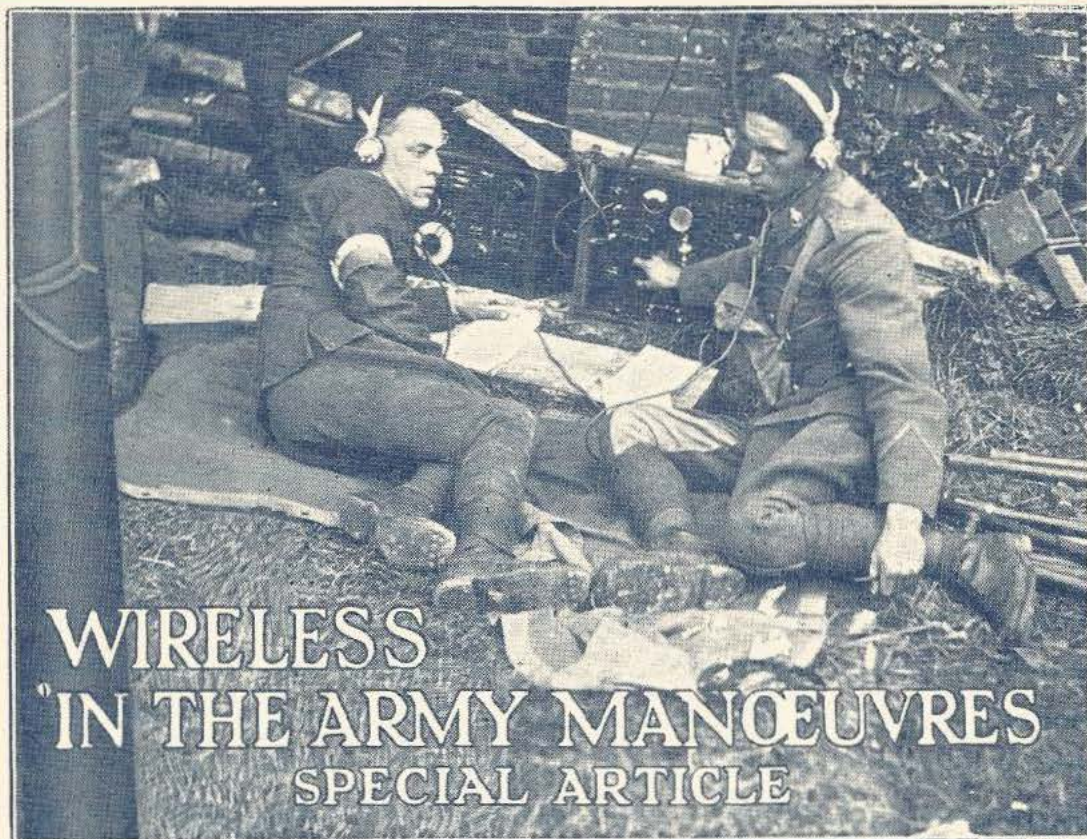

WIRELESS
IN THE ARMY MANOEUVRES
SPECIAL ARTICLE



**Ethovox
Standard
All-Metal
Loud Speaker.**

Height, 26 inches.
Diameter of flair, 15
inches. Adjustable
magnet-system. No.
961, 120 ohms resis-
tance. No. 962, 2000
ohms resistance.

REDUCED TO

£4 - 10 - 0



**Ethovox
Loud Speaker
with Mahogany
Flair.**

Height, 26 inches.
Diameter of flair, 15
inches. Adjustable
magnet-system. No.
964, 120 ohms resis-
tance. No. 965, 2000
ohms resistance.

£5 - 5 - 0

**Ethovox Junior
Loud Speaker.**

Height, 16½ inches
Diameter of flair, 11½
inches. Adjustable
magnet-system. Fitted
with five-foot flexible
lead. No. 967, 120
ohms resistance. No.
968, 2000 ohms resis-
tance.

£2 - 2 - 0



A bigger range of Burndept Ethovox Loud Speakers

THE Burndept Range of Loud Speakers has been increased to meet all tastes and demands.

On account of the enormous demand for the Ethovox Standard All-Metal Loud Speaker, a considerable price reduction has become possible. This instrument is noted for its excellent reproduction of speech and music, its tone being mellow and absolutely natural. It gives great volume without distortion.

The Ethovox Loud Speaker with Mahogany Flair is exactly the same size as the previously-described model and employs the same sensitive magnet-system. The flair is made of mahogany, the special method of construction combining great strength with neat appearance. This model will appeal to those who prefer the full, round tone given by a wooden horn.

The Ethovox Junior Loud Speaker gives very good results with low-powered broadcast receivers. It is 16½ inches in height and the sound conduit curves into an exceptionally large flair, no less than 11½ inches in diameter. At the price, the Ethovox Junior stands out prominently in its class.

An Ethovox Loud Speaker Gramophone Attachment is now obtainable. It can easily be fitted to the tone arm of any gramophone. Its price, either 120 or 2000 ohms resistance, is £3 - 3 - 0.

All these Burndept instruments are gracefully shaped and are coloured a deep mahogany shade. Further particulars are given in Publication No. 274, sent free on request.

The Burndept Range includes everything for radio reception from components to complete installations; Burndept products are guaranteed.

BURNDEPT
WIRELESS LIMITED

HEAD OFFICE:

Aldine House, Bedford Street, Strand, London, W.C.2.

Telephone: Gerrard 9072. Telegrams: Burndept, Westrand, London.

BRANCHES at Birmingham, Brighton, Bristol, Cardiff, Exeter, Glasgow, Leeds, Liverpool, Manchester, Newcastle, Northampton and Nottingham.

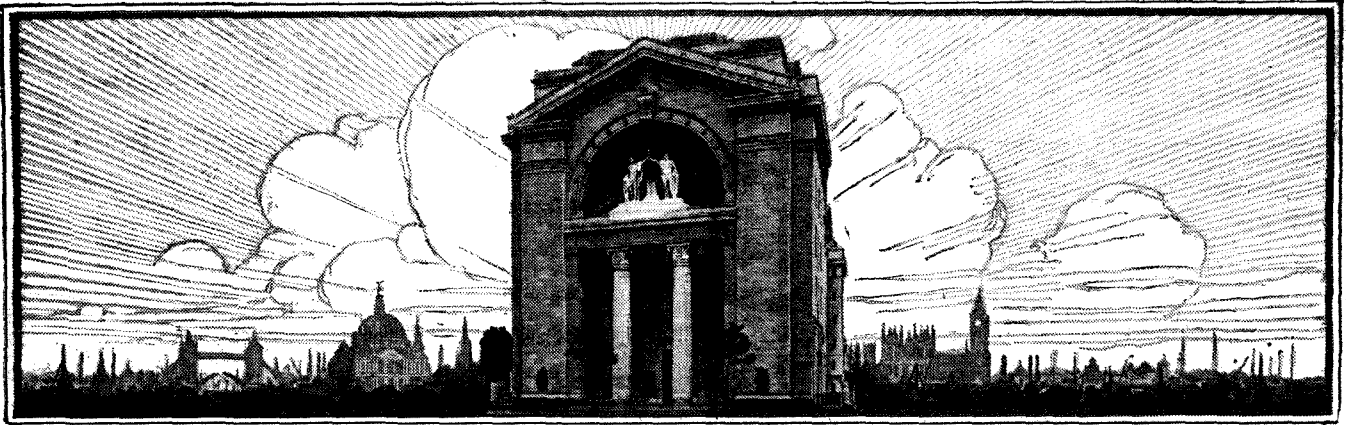

Radio Press LTD

Wireless Weekly
Phone City, 9911

Bush House STRAND-WC2

Selectivity



It has been pointed out upon several occasions recently that there can be no question that the detecting and low frequency amplifying portions of British receivers are unquestionably at least the equal of the corresponding apparatus in the United States. It would seem, however, that in the development of high frequency amplifying circuits of the special types called for to obtain a really high degree of selectivity, a point has been reached in the United States which makes it incumbent upon us to devote a good deal more attention to this subject.

The conditions prevailing in the United States, where there are commonly quite a number of fair-sized broadcasting stations operating in each large city, have made it essential that any receiver which is intended for the reception of distant stations shall possess a really high degree of general selectivity, and the forcing effect of this state of affairs upon development has resulted in rapid progress.

The advantages to be derived from a receiver of high selectivity need no emphasizing in view of the increasingly crowded condition of the European ether, and here is to be found a field for experiment which can be entered by any reader who possesses quite simple apparatus and the necessary patience and

perseverance. Elsewhere in this issue will be found a very suggestive article from Mr. A. D. Cowper, M.Sc., in which the author outlines one method of achieving the desired high selectivity, sufficient data being given to form an effective starting point.

which we have referred will be found a survey of the problem, and it is advisable to obtain a clear idea of the requirements to produce the desired degree of selectivity before attempting to devise special methods of achieving this end.

There is a familiar and well-established method depending upon the use of weak couplings between successive circuits, and the employment of this device is usually accompanied by some reduction in signal strength, which has, no doubt, been largely instrumental in preventing the British experimenter from making very much use of it up to the present.

He has felt that his main interest lay in obtaining the longest possible reception distances with the minimum number of valves, but the change in conditions which has gradually taken place is resulting in a state of affairs in which the long-distance receiving powers of a set may be very much curtailed by lack of selectivity.

The more general precautions, whose object is the reduction of damping in all tuned circuits, must also, of course, receive due attention, and a considerable amount of study should be given to the subject of the elimination of stray coupling between the earlier circuits of the receiver and those nearer to the detector, as a preliminary to any attempt to make a useful contribution to the subject.

CONTENTS.

	Page
Aerials for Short Waves ..	36
Extending the Broadcast Range ..	39
The Interference Problem ..	41
Jottings By The Way ..	44
Do Wireless Waves Rotate? ..	46
Loose-Coupled Transmitter Circuits ..	50
Wireless News in Brief ..	52
An Absorption Wavemeter ..	53
Wireless in the Army Manoeuvres ..	54
Constructional Notes ..	58
A Home-made Tap for Ebanite ..	59
Apparatus We Have Tested ..	6
Correspondence ..	62
Information Department ..	65

No one doubts the ability of the British experimenter to deal with a problem once it has definitely been presented to him, and there is here a very interesting opportunity for all to assist in bringing our receiving apparatus up to the standard called for by present-day conditions of crowding of stations in a limited frequency band. In the article to

Director of Research :
Major JAMES ROBINSON, D.Sc., Ph.D., F.Inst.P.
Deputy Director of Research :
Capt. H. L. CROWTHER, M.Sc.
Assistant Editor :
PERCY W. HARRIS, M.I.R.E.
Scientific Adviser :
Prof. G. W. O. HOWE, D.Sc., M.I.E.E.
Advisory Editors :
Prof. R. WHIDDINGTON, M.A., D.Sc., F.R.S.
Prof. C. L. FORTESCUE, M.A. M.I.E.E.

Edited by
JOHN SCOTT-TAGGART,
F. Inst. P., A.M.I.E.E.
September 30, Vol. 7, No. 2.

Nothing contained herein is to be regarded as permission or encouragement to infringe any patent rights.

Staff Editors :
E. H. CHAPMAN, M.A., D.Sc.
A. D. COWPER, M.Sc.
R. W. HALLOWS, M.A.
G. P. KENDALL, B.Sc.
A. JOHNSON-RANDALL
STANLEY G. RATTEE, M.I.R.E.
J. H. REYNER, B.Sc. (Hons.),
A.C.G.I., D.I.C.

AERIALS FOR SHORT WAVES

By Major JAMES ROBINSON, D.Sc., Ph.D., F.Inst.P.,
Director of Research to Radio Press, Ltd.

In the last two articles of this series in "Wireless Weekly" some questions of the propagation of waves were considered, and it was shown how there is a tendency to attempt to transmit wireless energy at an angle to the horizontal.

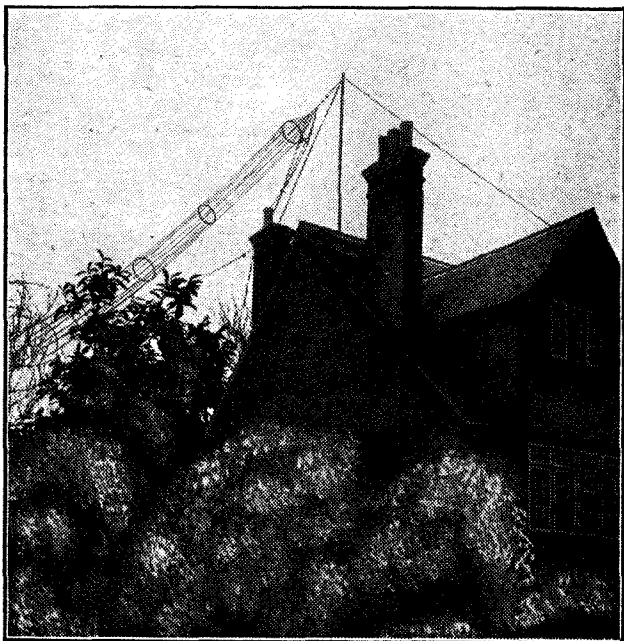

A typical cage aerial used for amateur transmission on short wavelengths.

WE will now consider how it is possible to transmit energy into the upper atmosphere. It has already been shown that from a simple vertical aerial, or from an aerial which is flat-topped, a considerable amount of energy is propagated at an angle to the surface of the ground. Curves were shown for the type of aerial and radiation when fairly long wavelengths were used, that is, when the wavelength used was longer than the natural wavelength of the aerial.

Horizontal and Vertical Radiation.

We shall now discuss the alternative case where the natural wavelength of the aerial is longer than the wavelength used. Consider an aerial which is not earthed but which is of the form of a Hertzian oscillator, such as that shown in Fig. 1, where A is the point where the power is put into the aerial. Now consider that this is excited by a wave one quarter the natural wavelength of the aerial in such a way as to obtain the complete oscillation of BAC as one wavelength. It is obvious that along a line OAX which is perpendicular to the aerial BAC there will be no radiation at all, because there will be an equal and opposite effect produced by the two halves of the aerial BA and CA. Further, we know that there will be no vertical radiation, so that we have the whole of the radiation shot up at an angle to the surface of the ground. It is possible to work out conditions for an aerial excited with an eighth of the wavelength, with a sixteenth of the wavelength, and so on. In fact, it is possible to work out the conditions when the wavelength used is some irregular fraction of the natural wavelength. This was done by Van der Pol in the year 1917, and was published in *The Proceedings of the Physical Society of London*. Further theoretical

results have also been published recently by Ballantine in the Proceedings of the Institute of Radio Engineers.

Distribution of Radiation

A number of figures showing how the radiation is distributed vertically are given from Fig. 2 to Fig. 5. The curves are again polar diagrams. Referring to Fig. 2, O is the point representing where the aerial is situated; OX represents the horizontal direction, and OY the vertical. The relative amount of radiation in any upward direction is given by the length of the line drawn from O to the curve OBAX. Thus, if OX represents the amount of radiation in a horizontal direction, then on the same scale OB represents the amount upwards at an angle BOX with the horizon, and OA at an angle AOX, etc.

Current Distribution

Fig. 2 is for the ordinary case of the wavelength in use being greater than the natural wavelength of the aerial, or, in other words, greater than 4.2 times the length of the aerial.

On the left of the figure the current distribution along the aerial is given. This is for an aerial earthed in the formal way, and without a capacity at the top. In such a case the current is zero at the top and a maximum at the bottom.

In some of the other figures the current distribution along the aerial is also shown, and in some cases it will be seen that the current is shown as zero at the bottom of the aerial. This appears to be a contradic-

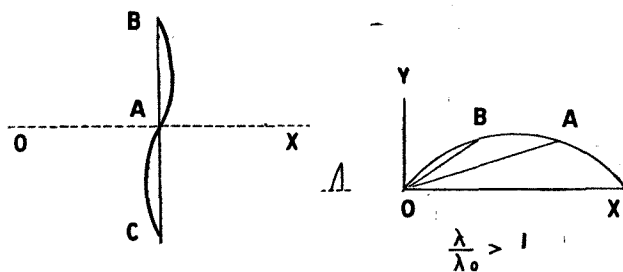

Fig. 1 (left)—The radiation from an aerial which takes the form of a Hertzian oscillator. Fig. 2 (right)—The horizontal and vertical radiation components for an aerial whose natural wavelength is less than the transmitted wavelength.

tion, but, in fact, is not so, for special arrangements can be made to have zero current at the base, and in these cases the aerial is not earthed at that point.

Further Examples

Fig. 3 is for the case of the wavelength in use equal to the fraction 0.39 of the natural wavelength of the aerial. In this case it is seen that there is considerable radiation horizontally, and that at an angle of 35 deg. with the horizon the radiation is zero. The

In this (his concluding) article Dr. Robinson discusses the problems of transmission on short wavelengths, and indicates how the principle of harmonic radiation may be utilised to advantage.

radiation splits up into two parts, there being a small amount of radiation nearly vertically.

In Fig. 5 this splitting up of the radiation into various parts is seen to be more pronounced. This is for the case where the wavelength used is $\frac{2}{3}$ rd of the length of the aerial, or actually $\frac{1}{4}$ th of the natural wavelength of the aerial.

Fig. 4 shows the upward distribution of radiation for the wavelength equal to the length of the aerial, corresponding to the aerial shown in Fig. 5. In this case there is seen to be no horizontal radiation.

Actual Trials

Both Van der Pol and Ballantine suggested that this effect might be used in order to test the Heavside layer theory, and, in fact, tests have already been made by the French on these lines. Professor Mesny instituted tests in the year 1923, in which he transmitted a certain form of radiation on 45 metres whereby the wavelength used was equal to the natural wavelength of the aerial, or somewhat greater than that, in other words, where the normal form of aerial was used. He also transmitted on 45 metres, whereby the length of the vertical portion of the aerial was equal to the wavelength and thus harmonic radiation was used. It was considered that in the latter case more radiation was sent into the upper atmosphere than in the former case. Observations were made by amateurs and by scientists in various parts of France, and, in fact, in England. The results which were obtained were very inconclusive, so that Professor Mesny could not definitely say that the results with harmonic type of radiation were any better than those with the more ordinary types of aerial.

Long Distance Communication

Very little appears to be known in England of this type of radiation, and very few records exist as to harmonic radiation having been used. The reason for

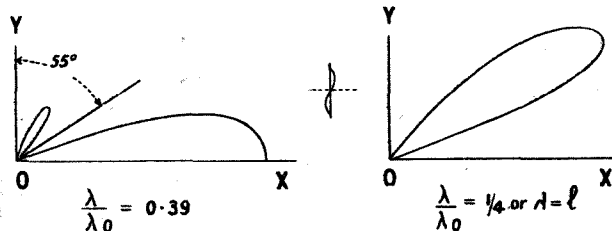
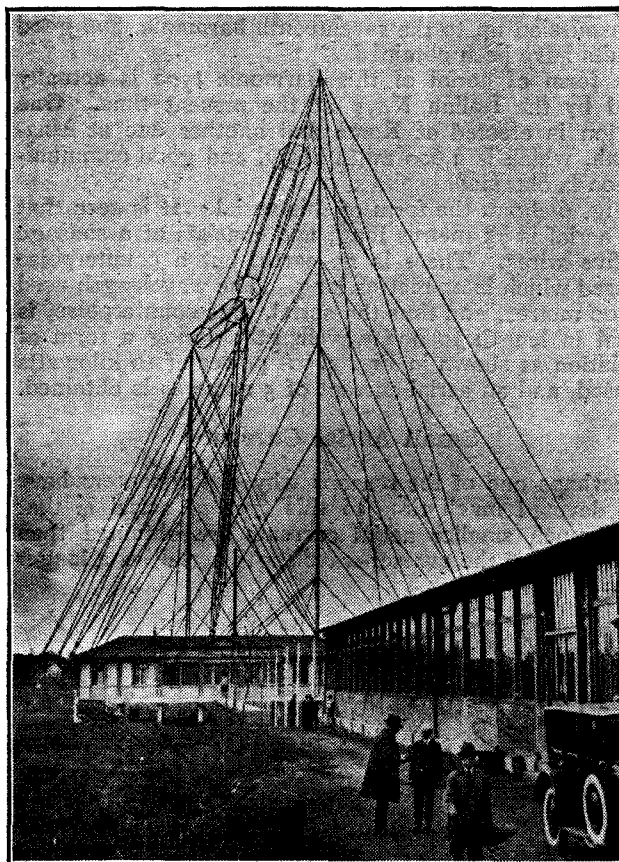

Fig. 3 (left) and Fig. 4 (right) show the angles of radiation for the conditions indicated by the formulae.

this appears to be that on short wavelengths such remarkable ranges have been obtained with such exceedingly small powers that experimenters have not troubled to consider whether they are using the most efficient form of aerial.

Future Restrictions of Power

The time is not very far distant, however, when experimenters will be compelled to devote



The elaborate aerial system erected by M. Belin at his private station at Malmaison, in France.

considerable attention to this point. In the case of commercial companies, it will be absolutely essential to consider the most efficient form of radiation. It will not be sufficient for a commercial company to state that it has got communication to Australia at a particular time of the day, but it will be necessary to guarantee communication for a considerable number of hours per day. In these circumstances the very best efficiency will have to be considered, and special attention will undoubtedly be given to this form of aerial. When a considerable number of experimenters, commercial companies and services are using these short wavelengths, there will be such a scramble for the use of wavelengths that power allowed may be subject to considerable restrictions. In these circumstances, experimenters, Services and commercial companies will undoubtedly devote considerable attention to use of harmonic aerials, and it will not be long before the merits of these aerials will be recognised.

Short-wave Phenomena

A peculiarity of short-wave working has often been reported that signals cannot be obtained from some transmitting stations at distances of 200-400 miles, but that at greater distances good signal strength is obtained. This appears to have an obvious explanation that there is no little horizontal radiation from these aerials, and that the only useful radiation from them is in an upward direction, and it does not get bent back to the earth under distances of 400 miles or more.

Practical Harmonic Aerial System

The Eiffel Tower aerial has been used for harmonic transmission up to the seventeenth harmonic, and good results have been obtained.

A form of aerial of this harmonic type is actually used by the Italian Navy at the present time. One station is erected at Rome and another one at Mas-sauah, which is 2,600 miles away, and good communi-cation is obtained.

Fig. 6 shows the form of this aerial. It is seen that the aerial is 75 metres long, and consists of a sausage of five wires. There is no earth, but a counterpoise is used which is 25 metres long. The wavelength used is 100 metres, and thus the aerial, plus counterpoise, is equal in length to one wavelength, giving a form of radiation as shown in Fig. 4. A power of 10 kilowatts is used, and an aerial current of 5 amperes is obtained.

Small Aerial Current

Perhaps one of the reasons why experimenters have not devoted much time to this type of aerial is that very much smaller aerial currents are obtained than in the case of the quarter-wavelength aerial, as a longer

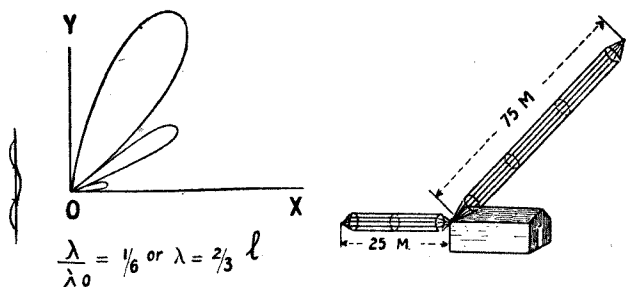

Fig. 5 (left) illustrates the splitting up of the radiation for the case where the wavelength used is two-thirds of the length of the aerial. Fig. 6 (right).—A form of aerial and counterpoise of the harmonic type in use at the present day.

aerial is used with the same input of energy. Suppose we use a three-quarter-wavelength aerial as compared with the normal quarter-wavelength aerial.

From the formula already given for radiation resistance, $R_a = \left(39.7 \frac{h}{\lambda}\right)^2$ ohms, we see that this varies with the length of the aerial. This formula relates, of course, to the case where the aerial current is almost constant throughout the length of the aerial, and thus we cannot employ it directly in the case of harmonic aerials in which the aerial current varies from zero to a maximum. The same general law holds, however, that the radiation resistance increases as the length of the aerial increases.

Thus, in the two cases of one aerial of the normal quarter-wavelength type, and of another with a three-quarter wavelength, the latter is three times as long, and thus has much greater radiation resistance. In case the input is the same in both cases, it is obvious that the aerial current must be smaller in the case of the three-quarter-wavelength aerial. This, however, does not mean that the distance which the wave will travel is smaller, for the total radiation is not necessarily diminished.

Experimenters should therefore not be discouraged on short waves because they sometimes cannot get large aerial currents.

Experiments in America

In the United States amateurs have used harmonic aerials to a considerable extent, but for very different purposes. One of the reasons has been that they already possess long wavelength aerials, and they have desired to use these aerials for shorter wavelengths. A method for doing this is to tune the aerial to three, five, seven or nine times the wavelength to be used. Then tune the primary circuit of their transmitter to the wavelength to be used. In this case the aerial is used as a harmonic aerial. Quite good results are reported with aerials of this type from the United States.

Aerial Design

There is one great precaution which must be taken with short-wave aerials. This is that the aerials must be taut in every respect and that they must not be allowed to blow about by the wind or to be jerked in any other way, for the slightest variation of an aerial will cause a variation in capacity to earth and capacity to other parts of the aerial, and thus cause a slight change in wavelength. When received by the heterodyne method of reception, obviously this small change in capacity will produce very considerable change in intensity of signals received. A point to recommend about short-wave aerials is that they should be built of solid rods which can be made quite rigid, while at the same time, if they are of the correct material, they can have exceedingly small resistance losses.

Conclusions

In this series of articles some general ideas have been given of the types of transmission and propagation which have been and are being used. The general tendency to the use of short waves has been indicated, and it is interesting to note that this tendency is brought about from practical considerations and also on theoretical grounds. Two of the most important theories of propagation, the Heaviside layer theory and the Meissner theory, have both shown how advantages can be obtained by using waves of shorter wavelengths than

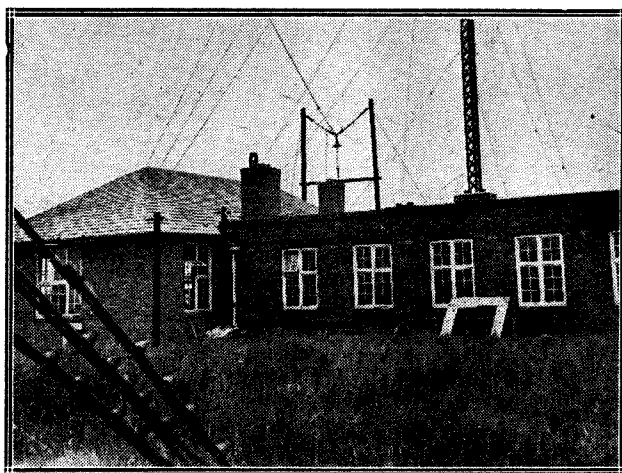

The aerial lead-in of the Post Office wireless station at Northolt.

those which have been in common use up to the present. These theories have only been briefly discussed in these articles, but elsewhere in this journal it has been indicated that work in this country, principally by Professor Appleton, tends to show that the Heaviside layer theory gives a much fuller explanation of all the facts.

Extending the Broadcast Range

By SYLVAN HARRIS.

The possibility of an extension of the band of wavelengths allotted to broadcasting in America may conceivably be paralleled in Europe as a result of the recent tests. Some of the problems which confront the designer of receivers to cover the extended band for the new conditions are discussed in this article.

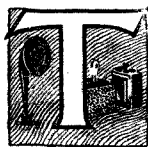

HERE is not a shadow of a doubt that there will be considerable consternation on the part of many American radio enthusiasts when the broadcasting wavelengths are lowered. There is also no doubt that the wave band will be lowered. There is nothing else to be done to clear up the congestion which now exists in the ether. Everyone is expecting it to happen soon.

There will probably be a great hue and cry when the extension comes. People will say: "It has been

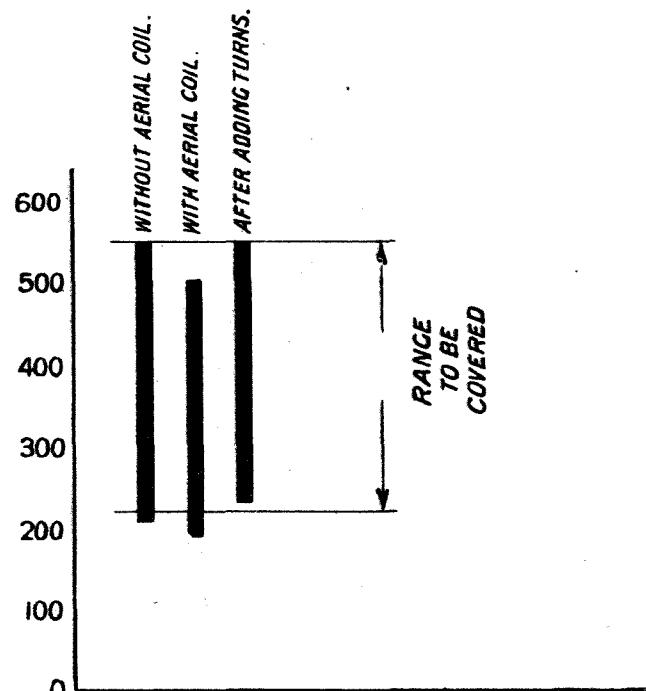

Fig. 1.—Showing the alterations effected in the tuning range of a receiver by changes in the aerial coil.

difficult enough up to now to cover the range of 550 to 220 metres (545 to 1,363 kc.). How will it be possible to cover a range of 550 to 150 (545 to 1,999 kc.)?

Tuning Over a Wide Range

There will be many arguments pro and con, but in the end, no matter how much arguing is done, ways and means will be found to overcome the difficulties. At least, if the total range cannot be covered in a single step, as is now done, it will have to be done in two or more steps.

As to the possibility of covering such a wide wave band—that is another question. Let us look at the problem from the point of view of the variable condenser, which is generally employed for tuning. But first there are three ideas which we must grasp firmly in order to discuss the matter properly.

The Basic Principles

The first of these three is the idea of *capacity ratio*. This is very simple. It is merely the maximum capacity of the condenser divided by the minimum. In other words, if the maximum capacity of the condenser is 500 $\mu\mu\text{F}$ and the minimum capacity is 20, then the capacity ratio of the condenser is 500/20 or 25 to 1. This is generally written 25 : 1.

The next idea, that of wavelength ratio, is just as simple. It is merely the longest wavelength we are considering, divided by the shortest. If we are considering a range of 600 to 200 metres, the wavelength ratio is 600/200 or 3 : 1.

The third and last of these ideas needed here is that which considers the relation between the capacity in the tuned circuit of a receiver and the wavelength to be received. This is generally known; the wavelength is given by the formula:

$$\lambda = 1884 \sqrt{L \times C},$$

in which L is the inductance in the circuit in microhenries (μH), and C is the capacity in microfarads (μF). The point that is of importance in connection with all this is that the wavelength is proportional to the *square root* of the capacity in the circuit.

Capacity and Wavelength

That is to say, we shall have to quadruple the capacity to double the wavelength, or increase the capacity nine times to triple the wavelength. Or to look at it another way, we may regard the capacity as proportional to the square of the wavelength; to

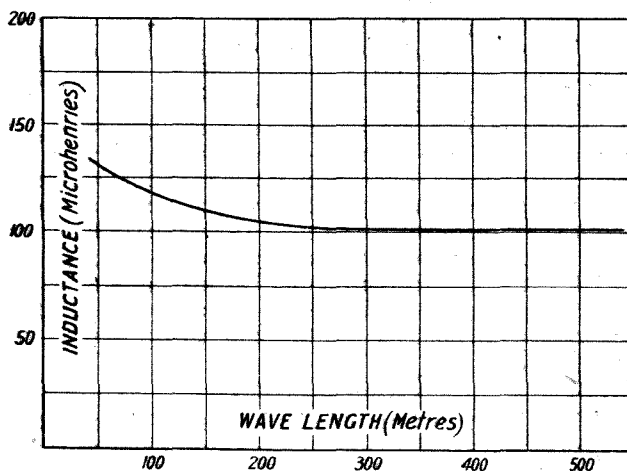

Fig. 2.—Illustrating how the inductance of a coil increases with an increase in frequency (decrease in wavelength).

double the wavelength we shall have to quadruple the capacity, etc.

Having assimilated these basic ideas, let us now co-ordinate them for the purpose of analysing our

problem. Suppose we are considering a wavelength range of 600 to 200 metres (499.7 to 1,499 kc.). This is a wavelength ratio of 3 to 1. Since the capacity is proportional to the square of the wavelength, we should then require a capacity ratio in our tuning condenser of 9 to 1 to cover the range completely.

It is a relatively simple matter to cover a 3 to 1 wave range with a coil and condenser isolated in space. But when the coil is coupled to another coil, as our secondary tuning coil is coupled to the aerial coil, there is another consideration. This is that the mutual inductance between the aerial coil and the secondary reduces the effective inductance connected across the tuning condenser.

Experimental Proof

This can be shown by experiment. A simple single-layer coil is connected in series with a condenser and thermo-galvanometer. This coil has a primary of a few turns wound directly upon the secondary winding. The circuit is then excited by a small oscillator, and the wavelength range of the coil and condenser noted for both the maximum and minimum settings of the condenser.

This is done by placing the condenser at the desired dial settings and measuring with a wavemeter the wavelength at which the galvanometer deflections are a maximum.

The primary coil is then connected to the aerial and earth, and without making any other changes in the circuits, similar measurements of the wave range are taken. Measurements are given in the following table from an experiment carried out on these lines:—

	Maximum Capacity	Minimum Capacity
Without aerial	550	215
With aerial	507	198

This was not done for the purpose of expounding a new theory. The principles have been known for a long, long time. But it is surprising how much the aerial coupling coil can affect the wavelength range.

Adding Aerial Turns

Now, it was noted above that the aerial coupling has a maximum wavelength of 507 metres. This will not permit us to tune in stations above 507. The wave band in America now extends to 550 metres (545 kc.). Suppose we add a few turns of wire to the coil to make up for this deficiency. What will happen?

To begin with, we shall reach our 550 metres, of course. But, at the same time, we shall raise our lower wavelength limit, and instead of being able to tune to 198 metres (1,514 kc.), we may be able to go only to, say, 220 metres, or even 240 metres. How low we shall be able to tune depends upon how closely the aerial is coupled to the secondary, and also upon the other capacities existing in the circuit, and whether or not the inductance of the coil changes with the frequency.

Lowered Range

This is illustrated graphically in Fig. 1. The vertical black column on the left indicates the range of wavelength obtainable without connecting the aerial and earth to the primary coil. This range is 550 to 215 metres (545 to 1,395 kc.). With aerial and earth connected, the wavelength range is lowered to 507 to 198 metres (591 to 1,514 kc.). This makes it impossible to reach the longer wavelengths, although we can reach the shorter ones. This is shown by the middle column in Fig. 1.

When we add sufficient turns to the secondary coil to make up for this loss of inductance, the wavelength is raised to 550 to 240 metres (545 to 1,249 kc.). We are now able to tune to the upper wavelengths as before, but are not now able to tune to the lower ones.

The reason for this is that the coupling of the aerial circuit to the secondary lowers the upper limit more than it lowers the lower limit, whereas the addition of the extra turns of wire changes both limits to nearly the same extent. This is indicated by the right-hand vertical column in Fig. 1.

Inductance and Frequency Changes

When a coil has considerable capacity, as is the case with multi-layer coils, the inductance changes as the frequency (or wavelength) changes. (See Fig. 2.) Over the longer wavelengths, say from 600 to 300 metres (499.7 to 999.4 kc.), the inductance does not change appreciably, but it is likely to increase very rapidly as the wavelength is made shorter and shorter. This will add to our difficulties in getting down to the low wavelengths.

Now let us consider what difficulties we shall meet when we try to get down to 150 metres (1,999 kc.).

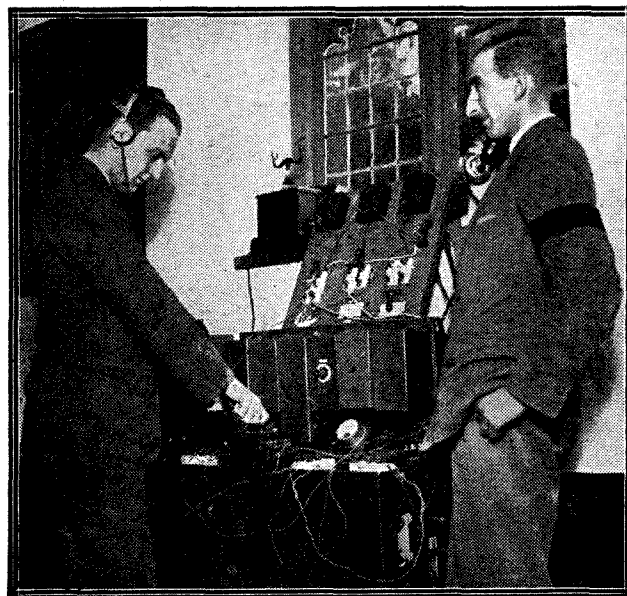

Some of the apparatus installed by the B.B.C. in Stoke Poges Church, whence a successful broadcast was recently carried out.

The total range of 600 to 150 metres represents a wavelength ratio of 600/150 or 4 to 1. As has been explained above, this would require a capacity ratio of 16 to 1. In the old case, where we covered a range of 600 to 200 metres (499.7 to 1,499 kc.), there would have been no difficulty in covering the range. The secret of the problem lies in employing loose-coupling between the primary and secondary, and in using coils with low distributed capacity.

The two cases are compared in the table below:—

Wavelength Range Desired.	Wavelength Ratio.	Capacity Ratio Required.
600-200	3 : 1	9 : 1
600-150	4 : 1	16 : 1

(Continued on page 60.)

The Interference Problem

By A. D. COWPER, M.Sc., Staff Editor.

In this article some of the factors governing selectivity are discussed, and a method is suggested for overcoming the difficulties involved.

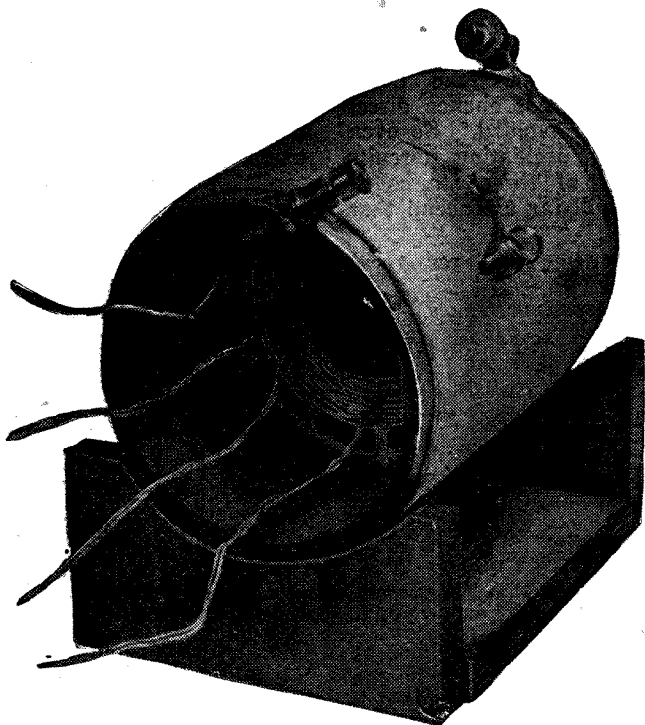

The solenoid grid coil described by Mr. Cowper with the tapped aerial coil placed under the filament tapping point.

COAST dwellers and those in the immediate vicinity of a commercial wireless station experience extreme local interference which is not confined closely to one frequency. Similar local interference is threatened in London if and when another broadcasting station is opened in a south-eastern suburb to provide alternative programmes. For cutting through such interfer-

sharply tuned; the real difficulties arise when the same extreme degree of elimination is needed on many frequencies.

Tight H.F. Couplings

Since extreme local interference with broadcast telephony has not been so conspicuous and universal a problem in Great Britain as it has become during the last year or so in the States, the attention of the British experimenter has been directed principally towards the obtaining of some degree of efficiency in high-frequency amplification by various types of (in effect) "tight" interval H.F. couplings, where such couplings are used in broadcast receivers, increase of range rather than extreme selectivity at all costs has been his object.

It is a commonplace to any careful observer that the natural selectivity of any reasonably well designed oscillating circuit, not deliberately damped for the sake of an expensive stability, is sufficient in all ordinary cases for the separation of distant telephony stations which are not actually giving an audible mutual heterodyne, i.e., for any useful purpose in broadcast reception.

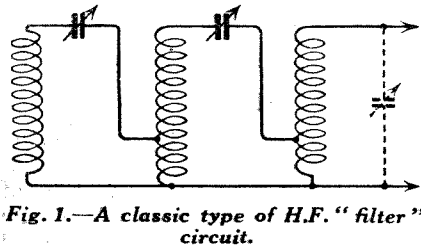

Fig. 1.—A classic type of H.F. "filter" circuit.

ence in order to receive distant stations there are available at the present time two practical alternatives.

These are the super-heterodyne with its many valves and small frame aerial, and the multiple filter-circuit used in conjunction with an ordinary outside aerial. A single interfering station is easy to eliminate by a proper trap, if fairly

Single Circuits

Practical experiment under conditions of extreme local interference of a fairly broadly-tuned variety has convinced the writer that it is not practicable to obtain a sufficiently sharply-peaked resonance curve in a single secondary circuit to cut down the intensity of, e.g., the local broadcast station's signals at suburban distances to an extent that merges them in the inevitable mush

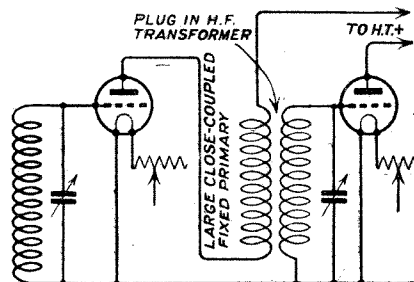

Fig. 2.—A common form of H.F. coupling employs tightly-coupled windings in the transformer.

or beneath the threshold value of local noises; that is to say, practically to extinguish them. This is in connection with an outside aerial of fair efficiency, and considering the practical case of reception of another

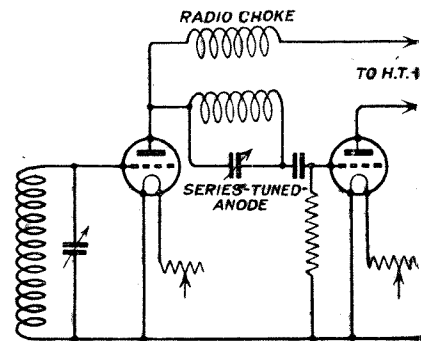

Fig. 3.—Another form of "tight" H.F. coupling is the series tuned anode method.

distant broadcast station on a neighbouring frequency not actually interfering directly by audible heterodyning with the first.

Reaction Distortion

Even with the use of critical reaction to eliminate much of the grid damping, except with some tricky, unstable circuits with tuned reaction effects, London will always come through audibly, in my experience, over most of the scale, and swamp the other stations. The question of reaction distortion (due to narrowing the resonance peak to such an ex-

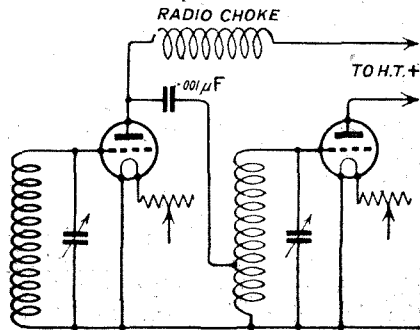

Fig. 4.—Auto-transformer H.F. coupling may be described as a form of loose "filter" coupling.

tent that it will not accommodate safely the audio-modulation side bands which necessarily accompany the main wave) begins to be serious when this degree of selectivity is attempted. The familiar hollow sound and "plummy" speech become prominent when reaction is pushed too far in an attempt still further to sharpen the resonance peak.

Multiple Filter

However, if one is prepared to sacrifice a certain amount of high-frequency amplification, and add one or two valves, for the sake of a sufficient degree of selectivity, the problem is very simply solved. By

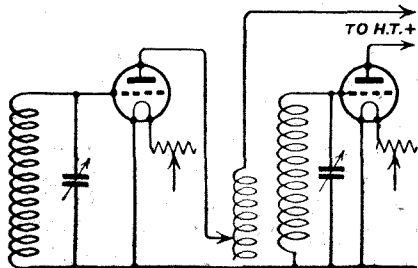

Fig. 5.—A type of coupling similar in effect to that shown in Fig. 4, with tapplings on the primary of the H.F. transformer.

loosening the coupling at each stage and by introducing oscillating circuits of fair design and of but moderate resistance at each point in several successive stages, the selectivity of the whole circuit is very greatly increased, without introducing extraordinarily fine tuning or troublesome instability.

Multi-stage Filters

If we have several lightly-coupled circuits of roughly the same resonance characteristics, the degree of selectivity of two stages is something like the square of the degree of selectivity of the one, and with three stages (other things being equal), it approaches the cube, always provided that chance direct back-coupling is avoided. So even with mediocre oscillating circuits the selectivity of three stages of "filtering" will far transcend that

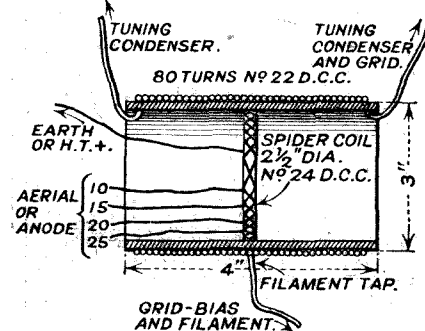

Fig. 6.—The circuit and the arrangement of aerial and grid coils described by the author.

of one first-class circuit, whilst at the same time there will not be the excessively narrow resonance peak which spells audio distortion as well as hair's-breadth tuning.

Selectivity and Stability

Fortunately, that very loosening of the coupling and complete elimination of all avoidable back-coupling

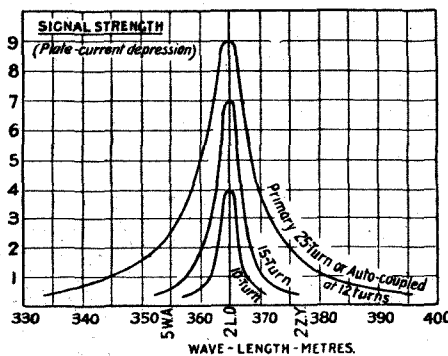

Fig. 7.—Resonance curves for various numbers of turns in the primary inductance, plotted on 2LO's transmission.

required for selectivity will at the same time make for stability. It might be questioned whether it is really necessary to use valves at all for coupling such a multiple filter-circuit, since amplification is not its purpose; practical experiment again shows that the actual degree of coupling necessary in a conventional type of tuned filter-circuit (Fig. 1) (such as has long been in use in commercial wireless telegraphy receiving circuits), for the short waves at

least and for broadcast telephony, does not permit of attaining the required degree of selectivity with two low-loss circuits in series.

Loose H.F. Couplings

The present writer has described (*Wireless Weekly*, Vol. 3, No. II; Vol. 6, No. 14) extremely selective circuits in which the light inter-valve coupling is obtained by an auto-transformer device, with an "anode tap" on what is, in each case, practically a tuned anode. By lowering

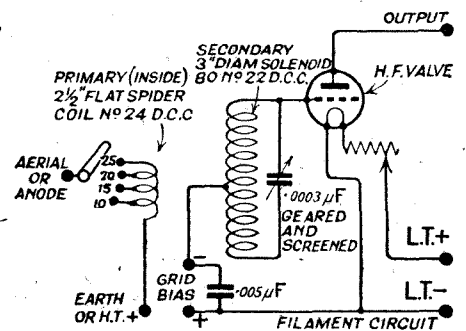

this tapping point towards the "earth" end of the tuned anode inductance, whether this be connected to H.T. plus or actually to the filament circuit, the coupling is proportionately lightened, and, incidentally, the natural stability of the circuit is increased.

The latter fact is utilised effectively in one form of commercial

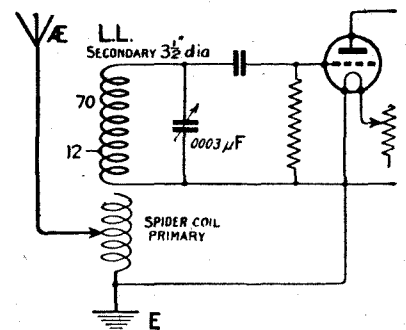

H.F. coupling device after this plan. It is easier in some cases, however, to get the requisite light coupling by the use of an independent tapped primary anode inductance, with a light magnetic coupling to the following secondary grid coil; in other words, with a loose-coupled H.F. transformer of special design.

Capacity Couplings

The importance of casual direct capacity coupling has been empha-

sised by several writers. Since such casual electrostatic effects are roughly aperiodic, they will be operative (within the frequency-belt considered) with almost undiminished intensity throughout the tuning-range of the receiver, rendering the tuning-out of the local interference impossible at any point. The effective elimination of an important part of this casual coupling is facilitated by the device suggested in an article in *Wireless Weekly*, Vol. 6, No. 19,

in spite of the several necessary tuning-points.

Filter-Unit

A filter-unit can therefore be made up, consisting of a coupler with a tapped spider primary inserted within a solenoid secondary of moderately good design. The latter provides the grid-tuning inductance of the succeeding valve, the anode of which is connected to the following filter-unit or rectifying unit. The only

rotors; the first and last (or detector) stages are better controlled separately.

Short Waves

On very short waves, where the natural frequency of the aerial is approached, a low primary tapping or even a series detuning condenser in the aerial may be needed. In the tests made with the circuit on a large high aerial close in to the disturbing stations (2LO and Northolt), the best tapping point appeared to be at about 15 turns in each primary when two separate filter-stages were in use, or 20-25 turns with one stage, the best aerial connection depending, of course, on the characteristics of the aerial used, and on the frequency being received.

Practical Trial

No trouble at all was experienced with self-oscillation, provided that the inductances were arranged carefully with minimum magnetic coupling, i.e., at right-angles and well separated; sensitive reaction was then applied on the last (detector) valve alone, a small amount of inherent reaction being inevitably left in the tuned filter stages. An enormous increase in selectivity was immediately noticed on addition of

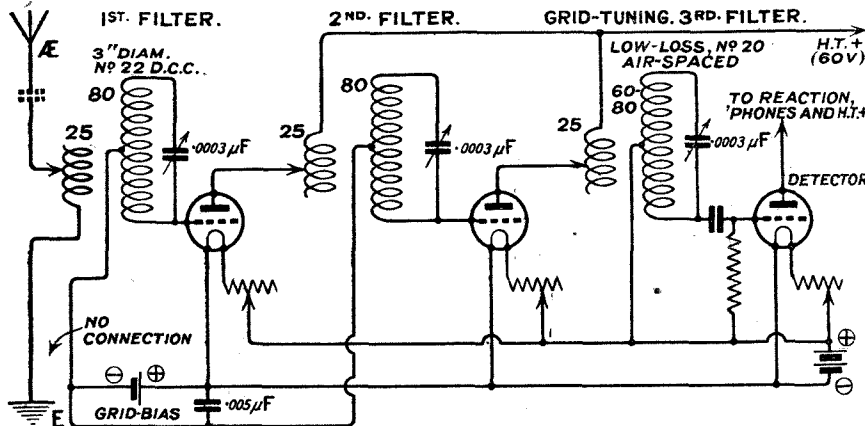

Fig. 8.—The circuit diagram of the complete receiver, recommended as a result of the experiments described.

by making the small tapped primary of each coupling transformer in the form of a flat spider coil (or small thin basket) wound on a slotted disc of cardboard and inserted inside a secondary inductance wound as a single-layer solenoid of a substantial gauge of wire on a dry cardboard or skeleton low-loss former. By making a "filament-tap" in the length of the latter inductance, and placing the primary directly under this point, the casual capacity coupling is reduced to a very small degree indeed, as only the outer edge of the flat primary coil is presented to secondary turns themselves very nearly at earth potential.

Ease of Control

A kind of "Hartley" type of circuit results, and the particular suggestion made here is to repeat this light magnetic coupling between a small symmetrically placed primary and fairly low-loss Hartley-type secondary (without the usual anode connection of transmitting circuits) at each of two or three stages, using only some type of direct reaction on the last of the series, and utilising the inherent stability of such lightly-coupled circuits to prevent self-oscillation at preceding stages. No neutrodyning expedients are then needed, and the circuit becomes fairly easy to handle

essential difference between the filter and rectifier unit is that the latter must be equipped with grid-condenser and grid-leak, and some reaction device. A grid-bias cell is suggested for reducing grid-damping in the coupling valve.

The aerial-coupling unit is identical with the subsequent filter stages, the primary being connected to aerial and earth in place of to preceding anode and H.T. plus respectively. With identical inductances and light coupling the tuning

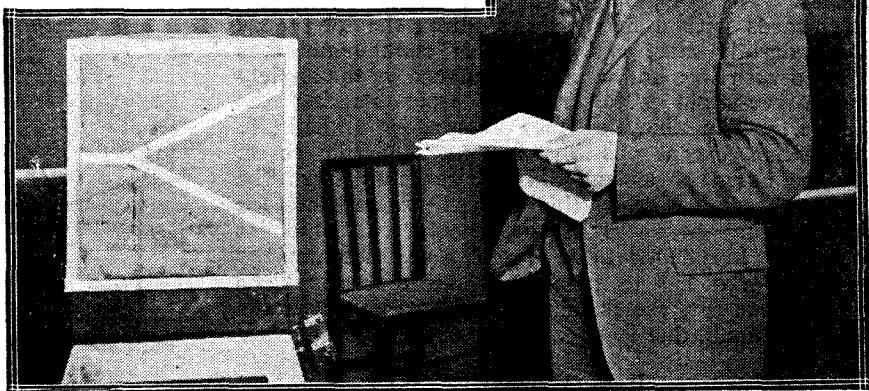

Mr. Harris broadcast a talk from the London station on September 18 on the subject of "Broadcasting in America."

of each such unit will be substantially the same. On practical trial it was found that two filter stages could be readily handled by a double tuning condenser with isolated

the one stage to the loose-coupled receiver, and a small increase of signal-strength when reaction was very carefully handled. The power-
(Continued on page 60.)



For it Again



ND now I see that "a noted physician" has been having a go at you and me and it. By it I mean, of course, wireless. There is nothing really strange about this, for ever since I can remember this fellow and other "noted physicians"

have been discovering all kinds of latent and terrible possibilities in the nation's hobbies. When I was a boy, cycling suddenly leaped into popularity. Every member of every family provided himself or was provided with a pair of wheels, and the whole nation took to the roads and the country lanes. Noted physicians, observing that they were enjoying themselves, at once began to examine the true inwardness of cycling.

Doleful Forecasts

They wrote to the papers all kinds of letters and articles, in which they were unanimous in foretelling that in twenty years' time (as they were writing in 1895 that would make it 1915) the nation would consist entirely of round-shouldered, bandy-legged creatures with enormous bulging calves, flat feet and thin, flabby arms. But there was something even worse than this. They stated that they had already observed the bicycle face, which was produced by the cyclist being forced to give his whole attention to the road in front of his nose. The bicycle face, which they told us would become a national attribute within the same period of time, was by no means a thing of beauty. The eyes, bulging a good deal, were turned downwards with a fixed glassy stare; the lower jaw hung slightly ajar, and the whole countenance was covered with lines and wrinkles produced by the anxiety and nerve-strain which resulted from steering the bicycle. The bicycle face somehow failed to materialise, except possibly in a few sporadic cases, but the noted physicians did not cease to warn the nation that other dread things might be in store for them if they persisted in their hobbies. Amongst these were lopsidedness due to golf, a complete atrophy of the legs owing to indulgence in motoring, the gramophone ear, the dancing splay-foot, and even the dealer's thumb, due to over indulgence in bridge.

Poor Wireless

Other noted physicians have discovered that devotion to wireless produces perfect health, complete wreckage of the human system, deafness, over-acute hearing, insomnia, sleepy sickness, dulness, brilliancy, moral rectitude and criminal tendencies. Their methods remind me a little of my friend Poddleby's racing system. Poddleby has only one flutter during the year,

on the Derby. As he simply cannot stand failing to back the winner he makes sure of success by putting a shilling on every horse in the race. The latest noted physician, however, has struck up a new line all to himself. It appears that the number of articles left behind by people in trains, buses and trams is steadily increasing. A few years ago it was, as you will recall, customary to leave your umbrella in the rack when you stepped out of the train. There was nothing extraordinary about this; everybody did it. But the modern traveller rises to far greater heights of forgetfulness.

Absentmindedness

It appears that often he will step from the carriage minus all sorts of queer things. Wooden legs, wigs, babies, tiger cubs, wads of bank notes, and so on are now commonly found by train searchers. You might think that the fellow who removed his boots in order to ease his feet and placed them in the rack would attract attention as he walked across the platform in his socks. But he apparently passes unnoticed amongst the crowd that streams from the train, almost every one of whom has made his little contribution to the lost property office. Stand upon the platform of any great station and watch them pass. That fat man in his shirt sleeves is a stockbroker who has mislaid his coat; behind him comes a stout lady trailing a mackintosh by one sleeve and fondly imagining that she is holding little Willie's hand; the man who is

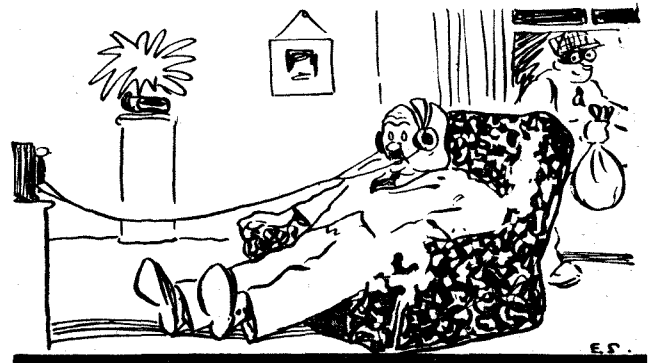

. . . Oblivious of his surroundings . . .

making unintelligible noises to a porter has left his teeth upon the carriage seat; and so on and so on. What is the reason of it all? Why does the golfer abandon his clubs, the fisherman his rod, the sweep his brushes, the circus owner his elephant? Simply because wireless has caught these unfortunate people in its dread grip.

So Simple

Our noted physician tumbled to the cause at once. When he was interviewed he did not hum and ha or play for time whilst he sought an explanation. Not he. He merely gave an airy wave of the hand and said that such a state of affairs was a sign of the times. To him it was as clear as mud that the widespread use of wireless has a devastating effect upon the activity of the brain. Is it not obvious that any man who sits for hours on end with the headphones clamped to his ears and his eyes fixed upon the condenser scales must become utterly oblivious of time and space and his surroundings? After a few evenings passed in this way the brain becomes numbed, the association-centres paralysed, and the memory blurred. In three months' time, such is the anti-pelmanising effect of wireless, the victim finds it utterly impossible to travel anywhere

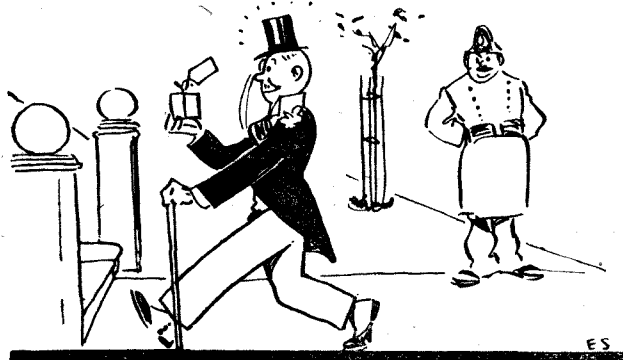

. . . Provided with a full wedding outfit . . .

by any kind of conveyance without leaving behind him a trail of derelict garments, parcels and personal possessions. There are, of course, stronger natures, like my own, which rise superior to this kind of thing, and can even profit not a little from the absentmindedness which devotion to wireless produces in others. Not long ago I was invited to a wedding, and was just about, with the utmost regret, to decline the invitation, since I remembered that my wardrobe contained no suitable wedding garments.

It's an Ill Wind . . .

However, a sudden inspiration came to me, and I journeyed to the place at which my friend the bridegroom was to receive his life sentence by a circuitous route which involved several changes. Picking my company with care during the journey, I led the conversation in each compartment in which I sat to the subject of wireless. This worked like a charm. The very first passenger to alight left behind a beautiful glossy topper, which fitted me to perfection. By the time that I reached my destination I was provided with a full wedding outfit of morning coat, pale grey trousers, patent leather boots, the correct tie, faultless gloves, a gold-mounted cane, an eyeglass, and even a gardenia for my buttonhole. I had also a charming little present for the bride in the shape of a pair of silver curling tongs. This just shows what a little initiative can do.

Professor Goop's View

Thinking that as a noted physician had been interviewed Professor Goop should have a similar chance, I repaired forthwith to "The Microfarads" to ask his opinion upon the subject of wireless and forgetfulness. When I was ushered into his study I found the Pro-

fessor running distractedly round in circles looking for a valve which he was quite sure he had laid upon the desk a moment before, though now he simply could not find it anywhere. Noticing at length that I was there, he advanced with his usual geniality to greet me. As he extended his right hand in order to grip mine a valve fell from it with a tinkling crash upon the floor. "Ah, there it is!" he said, "or rather there it was. I knew it could not be far away. Anyhow it does not matter, for at the moment I forget for what purpose I required it." I led him to a chair, and, having got him to sit down, proceeded with the task of interviewing him. "My dear Professor," I said, "some famous doctor—all doctors are famous when they get into print—has discovered that devotion to wireless produces forgetfulness and absentmindedness. I feel sure that readers of *Wireless Weekly* would like to hear what you have to say upon the subject." "Absolute nonsense," said the Professor, "utter drivel, complete tosh. Why, my dear fellow, wireless has exactly the reverse effect upon everyone who takes it up.

The Proof of the Pudding

"Take my own case, for example. Before I specialised in wireless I never could for the life of me remember just how many whatsitsnames there were in a thingemajig. Now I can tell you without a moment's hesitation that there are 644 . . . or, let me see, is it 1,728? I used to be rather absentminded, which led me unwittingly into little eccentricities in my dress. Now I think I may say that, entirely owing to my wooing of Mistress Radio, as the poets would say, my attire would be described by lady novelists as immaculate." He paused to straighten his tie, a process which he would have found easier had there been a tie to straighten. "But to turn for one moment from the subject which you have set me," he continued, "I am a little worried this morning about my health. For some reason that I do not understand my gait appears to be uneven. I have noticed ever since I got up that as I walk I am coming down heavily with the left foot and very lightly with the right." I pointed out as tactfully as I could that one was apt to be a little lopsided if one wore a hob-nailed boot on one foot and a carpet slipper on the other. "Thank you, thank you," said the Professor. "How foolish of me. Excuse me for one moment whilst I rectify matters." He left the room and returned presently wearing a golosh over the boot. "Some men," he said, "would have gone to the trouble either of taking off one boot or of putting on another. Such people are not blessed with the mental keenness engendered by wireless. As you see I have saved myself all the trouble by the simple expedient of donning a golosh, which now makes both my footfalls equally soft."

The Professor's Dictum

"Wayfarer, sit down at once, and contradict on my authority this latest and basest charge levelled against wireless. I do not wish to hide behind any pseudonym such as 'a famous scientist' or 'a well-known inventor.' No, you may tell the world that Professor Goop states emphatically that wireless does not produce forgetfulness or absentmindedness. You will forgive me—will you not?—if I leave you now and run away back to my own house, for I have important work to do." And, seizing my hat and stick, he left his study and ran.

WIRELESS WAYFARER

DO WIRELESS WAVES ROTATE?

By J. H. REYNER, B.Sc. (Hons.), A.C.G.J.,
D.I.C., Staff Editor.

In this concluding article of his series on modern problems of wave transmission Mr. Reyner discusses some of the peculiar phenomena noticed in long-distance communication, and shows how modern theories may be applied to explain them.

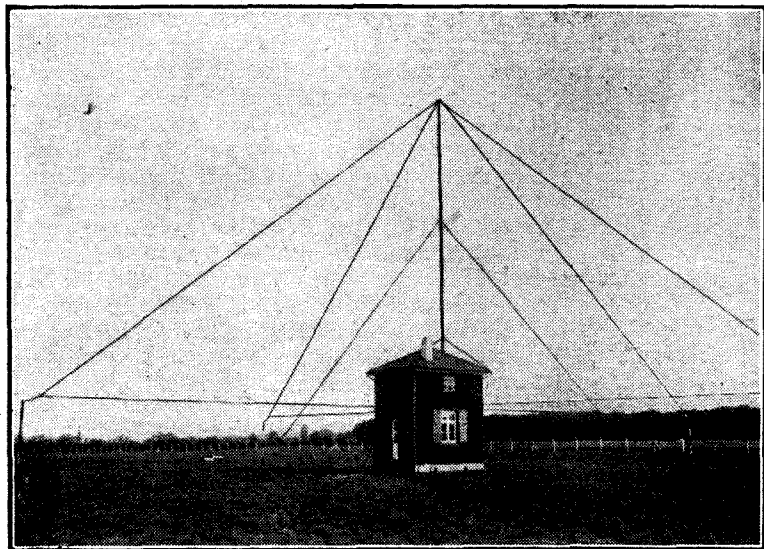

The peculiar "night errors" obtained at direction finding stations are probably due to a rotation of the wireless wave on its reflection at the Heaviside layer.



COMPARATIVELY short time ago the problems of wireless transmission over long distances were reaching a point where it might have been thought that some finality was being achieved. Experience shows that although with waves of the order of 300 to 3,000 metres (999.4 to 99.94 kc.) certain peculiar freakish effects could be obtained, wavelengths of the order of 10,000 to 20,000 metres (29.98 to 14.99 kc.) were very much more well behaved, if one may use the term, and with such comparatively low frequencies

ation, there are two waves arriving at the receiving point. One of these is the surface wave, and travels along the surface of the earth, the other being the space wave, which travels through space to the electrified layer, where it is caused to bend round and return to earth.

Now the shorter the wavelength of the vibration, the more rapidly is the surface wave attenuated, and in the case of the very short waves this surface wave is almost negligible at a very short distance from the transmitter. Thus, in this case, practically the whole of the transmission is effected by the space wave. Fig. 1 illustrates the production of the two types of wave at a transmitting aerial, and shows that the space waves are propagated in a direction inclined to the horizontal and will thus travel upwards in their flight until they reach the electrified layer, when they will be returned to earth in the manner which we have previously described.

In short-wave work, therefore, we are dealing almost entirely with these free space waves, which, having nothing to do with the earth, are subject to somewhat more peculiar effects.

Space Waves

Let us consider some of the effects which are obtained with very short waves. We have seen that in the case of the long-distance communi-

the Heaviside layer. To understand this very interesting effect, it is desirable to consider some of the phenomena of polarisation of light. We have seen that an electromagnetic wave consists of a series of bands of electric fields alternately in one direction and then in the other, and we have also seen that these bands travel outwards at right angles to themselves. This is illustrated in Fig. 2, which is reproduced from my previous article.

Now it will be obvious that there is an infinite number of directions in which the vertical fields may lie, and still be at right angles to the direction of propagation of the wave. For instance, referring to Fig. 3, the electric fields may be parallel to the line A B, or to the line C D, which is at right angles to A B, or in any intermediate position. The electric fields will still be at right angles to the direction of propagation, which is X Y, so that there are, as we have just stated, a variety of possible directions for the electric fields.

Light Waves

Now the light emitted by any source is a vibration of the ether just

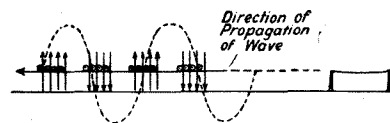

Fig. 2.—A wireless wave consists of a series of electric fields, first in one direction and then in the other, travelling in a direction at right angles to the fields.

as a wireless wave is, and is of the same type as the wave motion we have just considered. Moreover, in the case of light, the ordinary light we receive from any source is composed of vibrations in all directions out of the infinite number possible. That is to say, some vibrations will be as A B in Fig. 3, some as C D, and others in one of the multitudinous intermediate positions.

Polarised Waves

One of the peculiar effects which is noted with these space waves is that the plane of polarisation of the wave is altered at its reflection at

In certain circumstances, it is possible to eliminate all the vibrations except those which happen to be in a definite plane. For example, if the light is passed through a tourmaline crystal it is found that the light received on the other side of the crystal is composed of vibrations all in the same plane. That is to say, only vibrations of the type A B, or C D in Fig. 3, but not both, would pass through the crystal. Such light is said to be *polarised*.

Wireless Waves Polarised

The ordinary wireless wave is polarised when it leaves the transmitter. That is to say, the electric fields which are produced by the currents in the transmitting aerial, normally all lie in the same plane, usually the vertical plane. Thus, the normal wireless wave is of the type shown as A B in Fig. 3. Consequently, if an aerial is to respond to a wireless wave of this type, the aerial wire itself must be arranged vertically upwards. If the wire were placed horizontally, with no vertical

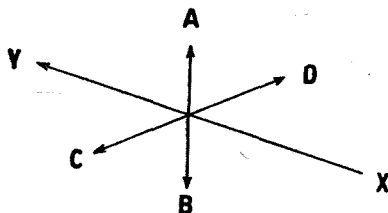

Fig. 3.—The electric fields in a wireless wave may be in any direction at right angles to XY.

portion at all, the response to the wave passing over it would be practically nil.

Rotation of Plane of Polarisation

There are various methods in optics for determining whether a light wave is polarised or not. I may perhaps at some future time describe one or two simple experiments which can be carried out with ordinary light which illustrate the phenomena of polarisation and which will help the student to obtain some idea of the phenomenon of wave motion in general. For the present, however, it will suffice to remark that if a ray of light is passed through a tourmaline crystal, and emerges the other side polarised, that is to say, with all the vibrations in one plane only, then it is possible by certain devices to discover the exact direction of this plane of polarisation.

Further, it is found that by passing this polarised ray of light through certain quartz crystals or other suitable substances, the plane of polarisation is rotated. That

is to say, that if the wave was initially vibrating in the plane A B, in Fig. 4, then, after passing through the quartz crystal, it would be vibrating in another plane. Consequently, if we had some device which was arranged to respond at a maxi-

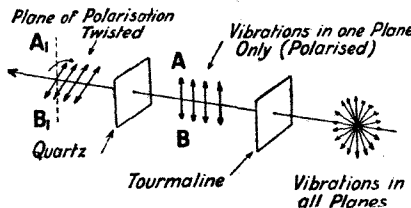

Fig. 4.—A quartz crystal will cause a rotation of the plane of polarisation in a light wave.

mum to waves polarised in the plane A B, this device would only respond partially to the waves after they had passed through the quartz crystal, owing to the fact that they were no longer polarised in the same plane.

Rotation at the Heaviside Layer

Now this rotation of the plane of polarisation can be explained mathematically on the wave theory of light. Following this up, it is possible to show mathematically that a similar rotation could be produced in certain circumstances at an electrified layer during reflection from an electrified layer of upper atmosphere in the case of a wireless wave.

A wireless wave is similar in nature to a light wave, the only difference in the two cases being one of the relative dimensions of the waves themselves and the obstructions which they encounter. By making suitable assumptions, therefore, which are justified by our knowledge of the conditions, we can show that it is possible for a wireless wave to be twisted in this manner at this Heaviside layer.

Eckersley's Theory

As far back as 1920, T. L. Eckersley put forward a theory in

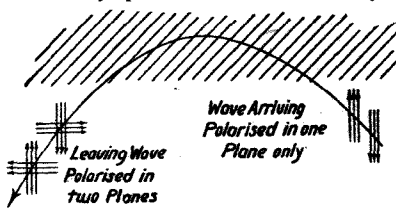

Fig. 5.—Under certain conditions a second wave is produced by reflection at the Heaviside layer.

which he showed that during the reflection from the Heaviside layer two waves were produced. One of these continued in its reflected course, polarised in the same plane as before, and the other one was

propagated downwards together with the first wave, but polarised in a plane at right angles to the first. This is illustrated in Fig. 5, which should make my meaning quite clear. The theory was developed to explain the night errors which were obtained in direction finding.

Night Errors

It is well known that at night time the bearing obtained on a frame aerial is very often quite incorrect. A bearing is taken by rotating the frame until the signal strength is zero, when, theoretically, the frame is at right angles to the direction of propagation of the waves. Now it is often found that the directions obtained by this method at night time are hopelessly incorrect, often by as much as 30 degrees or more. Eckersley showed in his paper that this peculiar effect could be explained quite satisfactorily by assuming the existence of this second wave polarised in a plane at right angles to that of the ordinary wave.

It will be observed, of course, that this theory necessitates reflection from an electrified layer of atmo-



Fig. 6.—Due to the earth's magnetic field a wireless wave slowly rotates in travelling from point to point.

sphere. The theory was admirably backed up by practical tests, and would seem, therefore, to be further evidence of the existence of a Heaviside layer.

Effects of Reflection

Recently, however, we have obtained still more interesting developments. It seems fairly well established that the reflection of the waves at the Heaviside layer produces waves polarised in different planes from the original wave. This theory has been developed by Appleton to explain the fading of wireless signals which is observed, and as I mentioned last week, the results obtained on his theory agree remarkably well with the results obtained in practice. I also showed last week that Messrs. Nichols and Schelleng have investigated the effect on wireless waves of the earth's magnetic field, showing that certain resonant effects were obtained in the neighbourhood of 1,400 kilocycles, corresponding to a wavelength of 214 metres.

Twisting Waves

They showed further, however, that another interesting effect resulted from the presence of the earth's field, and that was that the plane of polarisation of the wave

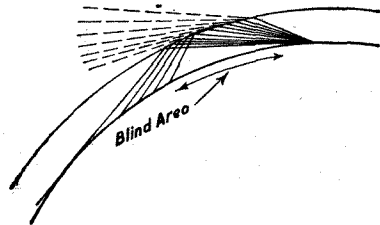

Fig. 7.—In some cases reflection does not occur at the Heaviside layer until after a certain distance, producing blind areas.

would rotate in its transit from point to point. That is to say, a wave would slowly twist round and round in corkscrew fashion somewhat as indicated in Fig. 6. It will be noticed that the electric fields are always at right angles to the direction of propagation of the wave. This is, of course, essential, because the ether, as we know it, is incapable of transmitting vibrations in any other manner.

Now it can be shown by analogy with the theories of light that the reflection of a wave from a suitable surface depends upon the manner in which the wave is polarised. A wave in which the vibrations are parallel to the reflecting surface is reflected in a different manner from the wave in which the vibrations are at right angles to the reflecting surface. This rotation of the plane of polarisation, therefore, would explain in

some measure the great differences which are observed with the very short waves in the range of transmission.

Skip Distances

To consider one of the problems only, that of skip distances, it is well known that with some waves it is impossible to hear the transmission until the range is greater than a certain distance. This means to say that the wave is not reflected from the Heaviside layer until after a certain distance. We can explain this by assuming that at this particular wavelength the twist in the wave is such that it reaches the reflecting layer polarised in such a manner that it is not reflected appreciably. It is easy to show by analogy with light that there are certain critical angles at which the light is not appreciably reflected. In a similar way the wireless wave in this case would not be reflected at the Heaviside layer, but would travel straight through it.

A little further round the surface of the earth, however, the wave would have rotated a little farther, the result being that the plane of polarisation is then different, and at this point the reflections may possibly be appreciable. In particular it is found in the case of light that when these waves are polarised in a plane parallel to the reflected surface, the waves are reflected irrespective of the angle at which they impinge, whereas, if they are polarised in a vertical plane, there are critical angles below which no reflections can take place.

This point is illustrated in Fig. 7, which indicates how it is possible for a wireless wave to be reflected at certain parts of the upper atmosphere only, the result being that it only reaches the earth in certain patches.

Dead Spots

The intervening distance, therefore, will not receive any reflected ray, nor will it receive a direct ray, as this has been damped out almost immediately after it has been transmitted. A particular instance of this was mentioned to me the other day by an observer who pointed out

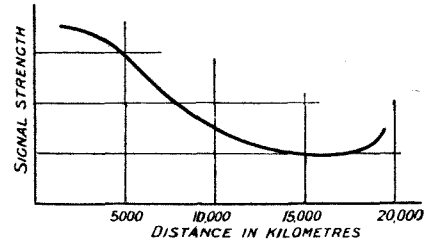

Fig. 8.—At distances of 18,000 kilometres the signal strength from Lyons was found to increase.

that when a British amateur was working New Zealand, he himself, only a few miles away, was quite unable to hear the transmitter.

Transmission to the Antipodes

I intimated last week that in addition to the ordinary theories of reflection at electrified layers, there is another factor which is responsible to some extent for the success of very long distance transmission. A short time ago some experiments were carried out by the French ship *Aldebaran*, in which the signal strength from Lyons and Nantes was measured daily for a considerable period at gradually increasing ranges. It was found that, as one might expect, the signal strength gradually fell off as the distance increased, but that at ranges of 18,000 to 19,000 kilometres, that is to say, very nearly half way round the earth, the falling off in signal strength was by no means as rapid as one might expect, and, moreover, towards the end the signal strength actually began to increase again. Fig. 8 illustrates the kind of curve which was obtained, plotting signal strength against distance from the transmitting station.

These results, therefore, indicate that, in addition to the ordinary attenuation of the wave during its progress round the earth, there is some additional factor entering into the transmission which acts in the opposite direction and tends to

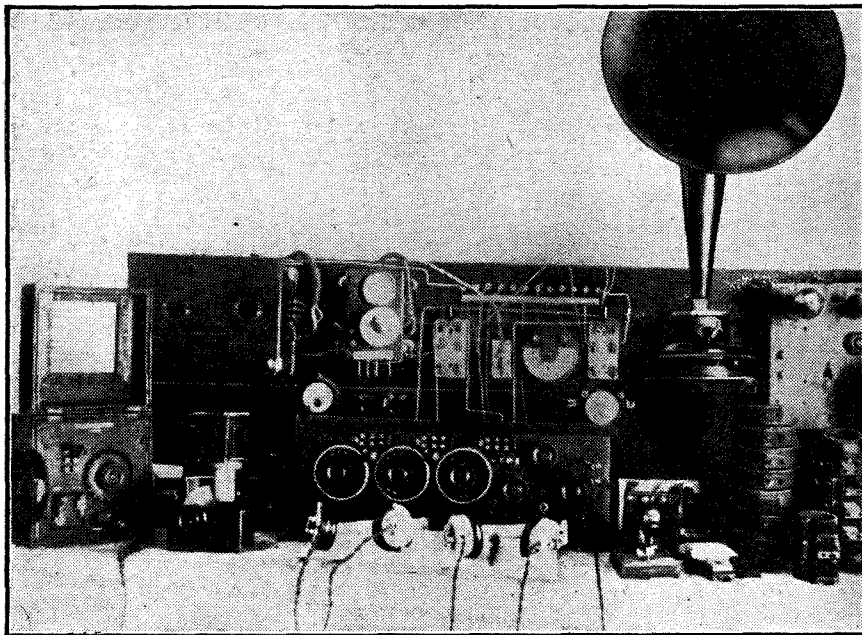

The equipment of an amateur station in India, with which long-distance reception has been achieved.

counteract the absorption of the wave. Professor Howe, in discussing the results of the *Aldebaran* experiments, put forward a theory to account for this phenomenon, the essence of which, curiously enough, was the same as one which had been previously proposed by Mr. Percy Harris as far back as 1915. The theory will be understood by reference to Fig. 9. If we assume a

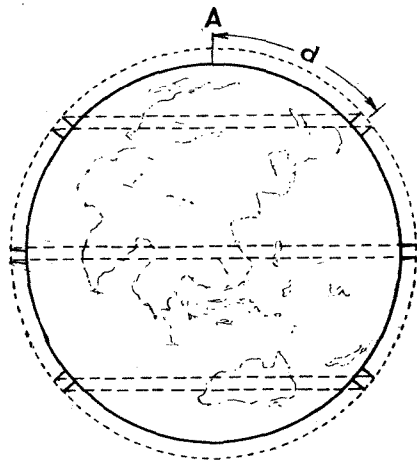

Fig. 9.—Illustrating the increase of signal strength due to the narrowing of the zone of energy near the Antipodes.

certain energy radiating from the transmitting station, this energy must travel outwards in all directions in a series of concentric circles, somewhat like ripples radiating from the disturbance caused by throwing a stone into a pond.

The ripples will, in the main, be confined within the space between the earth's surface and the Heaviside layer. Now neglecting the attenuation of the wave during travel, the energy in any one ripple travelling outwards will remain the same. The actual size of the ripple, however, increases as the distance from the transmitting station increases, and consequently the electric field strength will decrease in inverse proportion to the distance away. This is in accordance with the ordinary laws of the transmission of waves.

Increased Signal Strength

It will be obvious, however, that at a point one-quarter of the distance round the earth the diameter of the ripple will be a maximum, equal to the diameter of the earth. As the ripple continues its progress round the earth it will begin to decrease in size, and the electric field strength will correspondingly increase, until when it reaches the exact opposite

point to the transmitting point, the electric field strength will be exactly the same as it was at the transmitting station.

This, of course, is neglecting the effect of any absorption. We have, therefore, to superimpose on this effect the continual absorption of the wave during its progress round the earth, and the actual signal strength will be the sum of the two. From the *Aldebaran* experiment it will be seen that this increase of field strength, due to the gradual narrowing of the zone near the antipodes, is so rapid as to counteract the effect of the absorption, so that an actual increase in signal strength may result.

Conclusions

We see, therefore, that there is considerable evidence that the Heaviside layer is responsible for the phenomena of long-distance transmission with all its vagaries. The existence of such a layer is fairly well established from other sources, and the real problem is whether this layer of electrified gas is capable of providing the several effects which are observed in practice. It appears that, with the modifications proposed by Larmor, Appleton and others, all the observed phenomena can be satisfactorily explained, so that the modern tendency is towards re-establishing this theory once again.



By means of a quartz crystal, shown with a high-power transmitting valve for a comparison of the sizes, the frequency of a transmitting station may be accurately controlled.

**HAVE YOU GOT YOUR COPY OF
"WIRELESS"?**

No 3. OUT YESTERDAY.

ON SALE EVERYWHERE.

Loose-Coupling in Transmitting Circuits

By C. P. ALLINSON (6YF).

The importance of steadiness of the emitted wave, especially in low power transmission, is generally recognised, and this article suggests one method of improvement in this direction.

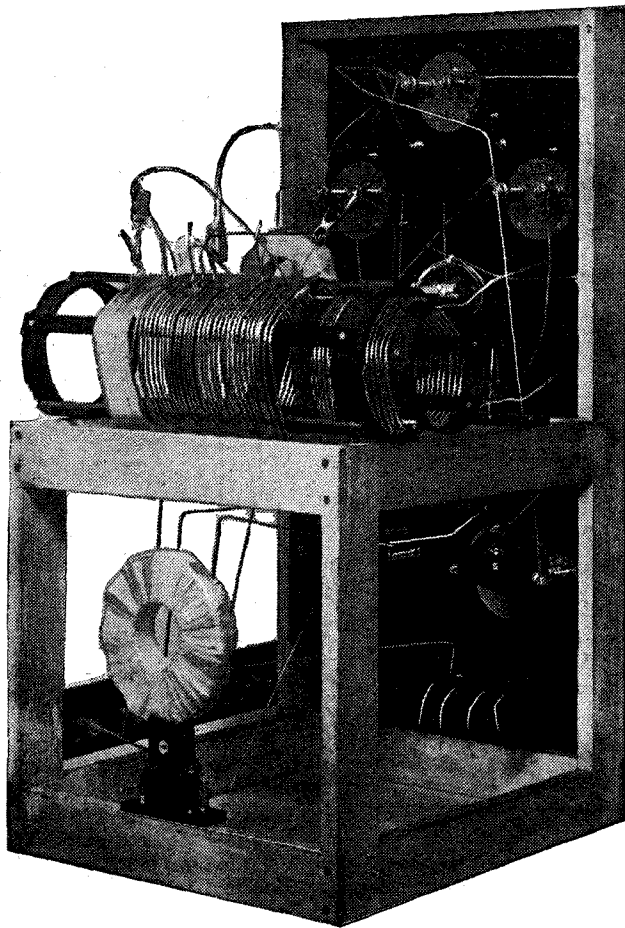

The aerial coil is here shown mounted inside one end of the main inductance coil in order to obtain a loose coupling.

Constant Wavelength

It is not always possible to erect an aerial, and to arrange the down-lead in such a way that the system

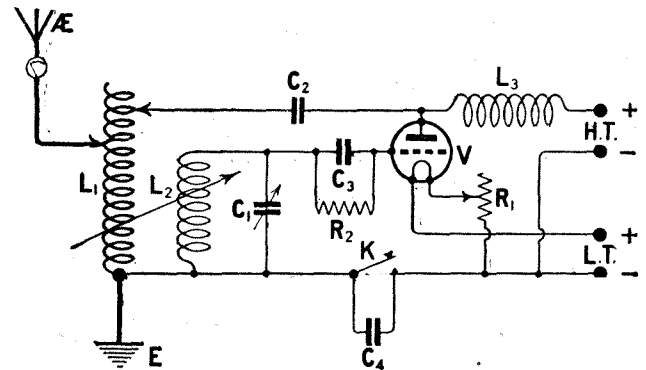
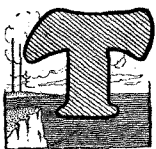

Fig. 1.—A typical direct-coupled transmitting circuit of the reversed feed-back type.

will not swing in a high wind, and it therefore becomes incumbent upon the transmitter to seek some other means if he is going to keep his emitted wave steady; and, apart from the master oscillator system, something can be accomplished in this direction by loose-coupling the aerial to the oscillating system.

Harmonics

In some cases it may even be found necessary to work with extreme loose-coupling, which is, of course, a disadvantage, as this results in less energy being transferred to the aerial. It is, however, much easier



THE amateur transmitter in the United States is now compelled to use loose-coupled aerial systems, partly on account of the interference that may be caused to broadcast listeners by the use of the direct-coupled transmitter, especially where raw A.C. or unsmoothed rectified A.C. is being used as a high-tension supply, but also to help eliminate "key-click," a form of interference that can be heard for quite a great distance, and is very annoying, as it cannot be eliminated by any means in the receiver. In England the use of the loose-coupled circuit is not, of course, compulsory, but it has certain advantages, and in some cases marked advantages, that make it well worth while experimenting with.

Effect of Swinging Aerial

With a close-coupled aerial system, when working on the very short waves, the swinging of aerial, earth, or counterpoise leads may be sufficient to throw the wavelength out quite a considerable extent, thus causing a swinging of the signal at the receiving end. On those wet, blustery nights, when conditions for reception and long-distance transmission seem to be at their best, this trouble will manifest itself most noticeably.

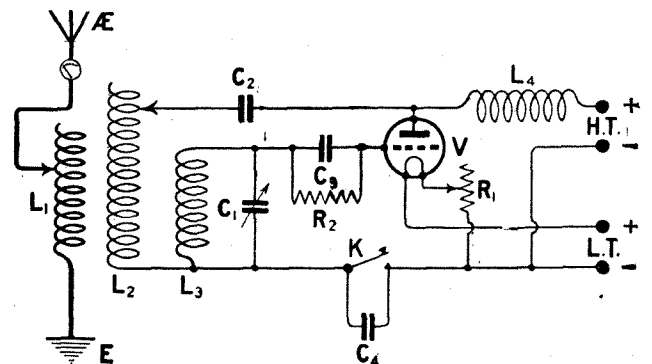

Fig. 2.—The circuit of Fig. 1, with the provision of loose instead of direct aerial coupling.

to read and copy weak and steady signals than to attempt to follow the vagaries of strong but swinging signals. Another advantage with the loose-coupled circuit is that it is less likely to radiate harmonics than the close-coupled transmitter, in which case, of course, it means that practically the whole of the energy

transferred to the aerial is being radiated on the particular wavelength on which you are working. It might here be mentioned that a point which is often confused by the amateur is the fact that aerial current and aerial radiation have often little bearing on each other. It is possible to have a high aerial current, a small percentage of

reaction control. When the aerial and this circuit are in tune we shall get, of course, the largest aerial current, and it will now take a much larger alteration in the capacity of the aerial to affect the emitted wavelength to any appreciable extent. In fact, if the coupling used is very loose, it may not influence it at all.

An Alternative Circuit

A direct-coupled transmitter is shown in Fig. 3, and in this, as before, the frequency of the emitted wave is governed by the amount of the inductance between the aerial and earth taps, the positions of the plate and grid taps and the setting of the variable condenser C_1 being adjusted to give the maximum aerial current. The loose-coupled circuit shown in Fig. 4 is preferable from several points of view. Not only does the question of a swinging wave become less serious, but also the adjustment of the circuit becomes much simpler. In each of these circuits the position of the filament tap is fairly important if the maximum output is to be obtained, and it will be seen that in Fig. 3 the alteration of this tap would also alter the wavelength being emitted. In Fig. 4, however, we have a simple oscillatory circuit L_2C_1 , which is coupled to the aerial circuit. The frequency of the emitted wave is governed by the circuit L_2C_1 , and the aerial tap and coupling between L_1 and L_2 are adjusted to give the maximum aerial current. It will be found that if the coupling between L_1 and L_2 is too close, as the condenser C_1 is turned, two resonant points may be shown by the aerial ammeter. This is due to the mutual inductance between the two coils. The coupling should therefore be loosened until only one resonant spot is found, but should not be loosened beyond this point unless the wave is reported to be swinging badly.

Conclusions

In concluding, I would therefore recommend to the amateur who suffers from a swinging wave to experiment with loose-coupling in his transmitter. Not only will it help him to cure this trouble, but it will also give him a more sharply defined wave, which, in the experience of many long-distance amateurs, has been found to carry better and to be read more easily at great distances. It will also help to eliminate key-click and that annoying "quacking" which occurs in some cases.

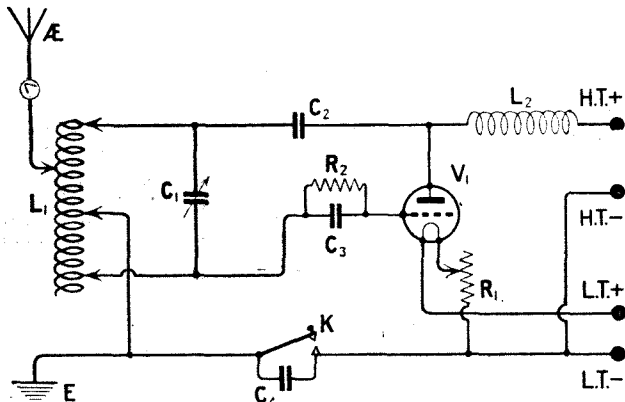

Fig. 3.—A form of Hartley circuit employing direct coupling.

whose energy only is actually being radiated. It may often be found, in fact, that an adjustment which gives a smaller aerial current will result in signals being received at a greater distance, and that an adjustment that gives a higher aerial current will result in signals only being received at a very short distance.

A Direct-Coupled Circuit

Fig. 1 shows a typical direct-coupled transmitting circuit of the reversed feed-back type. The wavelength transmitted is governed by the amount of inductance

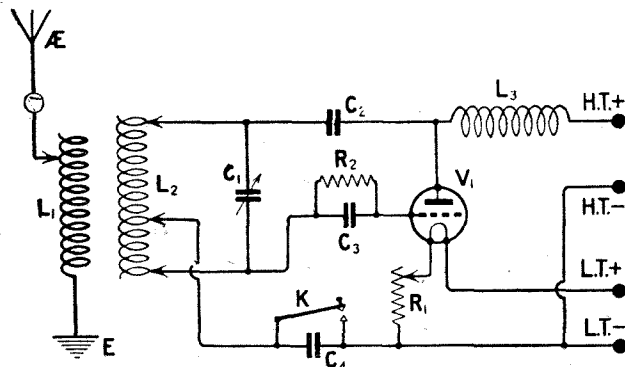
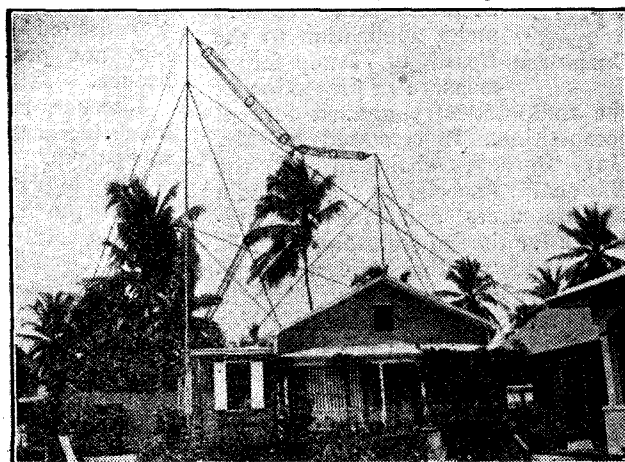

Fig. 4.—With loose coupling the adjustment of the Fig. 3 circuit is greatly simplified.

included between the aerial tap and earth. The adjustment of the anode tap and the grid circuit, however, have a decided effect on the aerial current and will need readjusting with every change of wavelength made. It will be seen, therefore, that any alteration of the capacity of the aerial will seriously affect the wavelength, and the swinging of the aerial or the swinging of the lead may be sufficient to cause such a change in capacity, with a resulting variation in wavelength.

An Improvement

Fig. 2 shows a similar circuit, only using a loose-coupled system. In this case the frequency of the transmitter is controlled mainly by the closed circuit L_3C_1 , the anode tap as before giving



The aerial system employed by an amateur transmitter at San Juan in Porto Rico.

Wireless News in Brief.



Wireless in Northern Canada. During the 2,000 miles' trip to the Far North of Canada, recently completed by Lord Byng of Vimy, the Governor-General of Canada, the party was in constant touch with the South by means of wireless. The North-West territories wireless system is operated by the Royal Canadian Corps of Signallers. It appears that broadcast reception in the Far North is very popular, especially during the autumn and winter. The long daylight hours of summer make broadcast reception almost impossible. Wireless telegraphy with the Governor-General's party was but little affected except in certain places, such as between high river banks, where reception faded or died away entirely, to re-appear when the boat emerged from between the high banks.

Foreign Trade Competition. Steps are being taken to make application to the Board of Trade for a measure of protection of the radio industry against foreign competition. It is stated by Mr. Guy Burney, chairman of the National Association of Radio Manufacturers' and Traders' Committee for the safeguarding of the radio industry, that foreign competition has been most destructive in the matter of headphones. Not less than two million pairs of these were sent into our market last year at prices approximately 50 per cent. below the price at which we can afford to market them in this country. Last year it became evident, he continued, that the Ger-

mans, Austrians and French meant to capture our market, and what they have already done in headphones they can just as readily do in loud-speakers and all other component parts that go to make up a wireless set.

Arrangements have been made for broadcasting a special tango band from the Savoy Hotel. This will in no way interfere with the usual relays of the Savoy Orpheans or the Selma Four.

On October 5 Miss Daisy Kennedy will provide the special feature at the London station, when she will broadcast a violin recital prior to her departure on an American concert tour.

Wireless Licences. The latest figures show that the number of wireless licences issued up to the end of last month was 1,423,000. During August 86,000 were issued—44,000 to people who had not previously taken out a licence.

Listeners on the wireless in Germany increased in July and August to 852,537.

The biggest increase—13,000—was in the Berlin area, thus bringing the total of Berlin listeners to 366,558.

The Telefunken Gesellschaft has secured the order for the construction of the new broadcasting station in Vienna, in competition against American and British tenders. The Vienna station is to be two-and-a-half times as powerful as the station just erected in Berlin.

Wireless Contracts with China. We understand that pressure by the United States on China to fulfil the terms of her agreement with the American Federal Wireless Company, and counter-pressure by Japan on the ground that the conditions of the contract of the Federal Wireless Company conflict with the terms of the Mitsui wireless agreement, have recently resulted in an effort on the part of the Chinese Government to compromise with the conflicting parties.

This year some 200 villages in the province of Moscow have been provided with reading rooms and wireless equipment, and in the city of Moscow itself there are 350 radio clubs with 15,000 members. There is also a fortnightly radio magazine, the *Radio Amateur*, issued in Moscow, and this has already achieved a large circulation.

Progress Abroad. Jamaica and Bermuda may now be added to the list of high-power wireless telegraph stations, and another distant colony (Rhodesia) is making active preparations for the extension of wireless communications. Salisbury will, under this scheme, soon be linked up with Pretoria, and as the preparations for beam reception and transmission are already well advanced in South Africa a new interest will be added to life in Rhodesia, which will then be practically in direct communication with Great Britain. The subsequent problem of efficient relaying from the main receiving station should not be difficult to solve.

AN ABSORPTION WAVEMETER

Some notes describing how a simple form of resonance indicator can be used for checking the wavelength of either a receiver or transmitter.

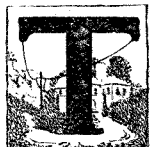

THE novice in wireless work may regard the construction of a wavemeter as a rather difficult or costly proceeding, that will also involve further outlay in getting it calibrated. There is, however, a simple form of wavemeter that can be used not only for reception work, but also for transmission. It consists of two components only, and can be put together in very little time. As will be seen from the photograph it consists simply of a coil or inductance and a variable condenser. The question, of course, that promptly arises is, how can such a circuit without any buzzer, crystal and 'phones, or indicator of any kind be used as a wavemeter? The answer is very simple, and can best be given by a description of the procedure to take in calibrating the instrument.

Method of Calibrating

Tune your receiver to your nearest broadcast station, of which you know the wavelength, bring the coil of the wavemeter (which may be a plug-in coil, or a home-made one fitted, as shown in the figure) close to your tuning coil, and turn the dial of the wavemeter condenser. You will probably find that, if the wavemeter is placed close to your receiver, the signal strength of the station you are receiving will go down over quite a large angle of the tuning condenser. Note the two readings where the weakening of signals begins and ends. Now remove the wavemeter a few inches from the set, and repeat the proceedings, till a certain distance from the set is found at which the wavemeter will cause the signal strength to drop only on one setting. This is the calibration point on your wavemeter for this wavelength.

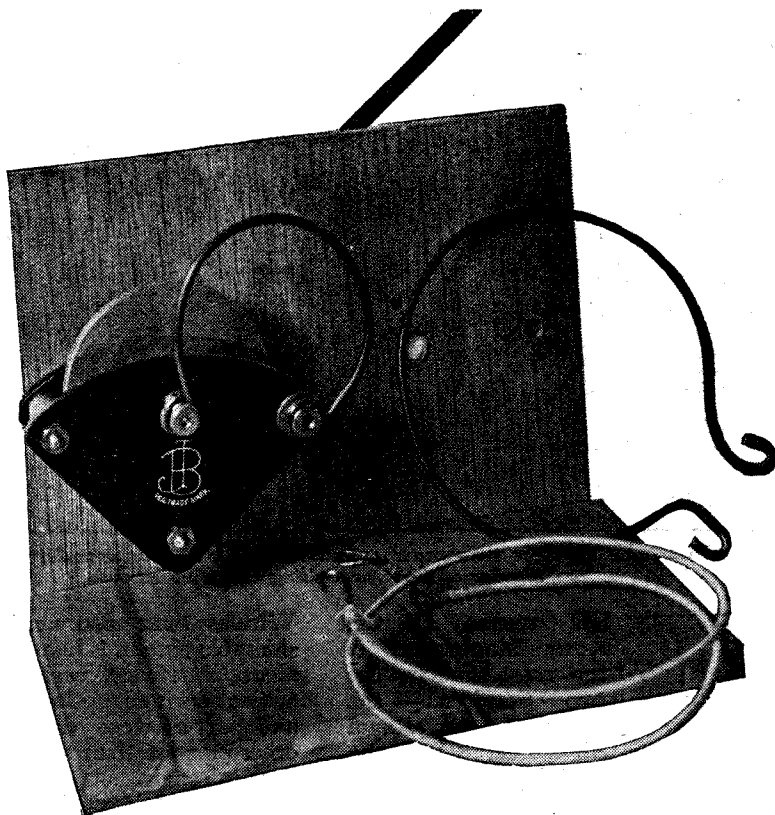

A wavemeter of the type described can be very simply made up, the only parts required being shown here, changes in the wavelength range to be covered being effected by the use of different sizes of coils.

Utilising Distant Signals

On distant signals where reaction or high-frequency amplification is being used, the same procedure can be employed, but a better reading can be obtained in the following manner. If the set is just on the oscillation point, it will be found that with comparatively loose coupling a reading can be found on the condenser, where the set will come right away from this oscillation point, and therefore the resonance point of the wavemeter will be much more marked than on the local station. You can thus obtain a reading from all the stations you can receive and of which you know the wavelength, and draw a wavelength-capacity curve. It is then a simple matter when receiving an unknown station to bring up the wavemeter, determine the reading on the condenser that brings about a diminution in signal strength, and read off the wavelength from the chart. By procuring a number of different

sized coils it is possible to cover any wavelength.

As a Transmitting Wavemeter

For use with a transmitter the procedure should be modified as follows:—Set the transmitter oscillating, and place the wavemeter about two feet or eighteen inches away from it, having connected a suitable coil to it, of course, with regard to the wavelength on which you wish to transmit. Now with the aerial ammeter in circuit, slowly rotate the dial of the wavemeter condenser till the aerial current is seen to drop a trifle. If this does not occur bring the wavemeter a little nearer to the transmitter and repeat the process. Eventually a position will be found where one setting, and one only, on the wavemeter condenser will cause a slight drop in aerial current. Your wavemeter chart will then tell you what wavelength you are actually working on.

G. L. H.



A portable wireless transmitting and receiving set in use under conditions similar to those prevailing on active service.

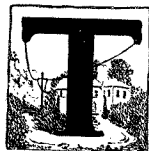

HE season of the Army Manœuvres is the great time for the two Services — the Army and the Royal Air Force. It is the time when the training for the whole year is put to a severe test; all schemes and instruments which have been designed in the course of the year are put under the most rigorous conditions—the equivalent of actual war conditions. By such a rigorous test various schemes can be approved or condemned, and, as regards instruments, weak points are then further brought out which do not appear in the ordinary course of the year's work.

Importance of Wireless

Wireless in the Army Manœuvres now takes a very large part, because the secret of efficiency in the Services depends upon good Communications. It is essential for the Commander-in-Chief to be instantly in touch with all units of his Command, and this is only possible if the Communications are in excellent order. As the years go by, wireless is taking a more and more important part in the Communications of our Forces.

As regards the Army, during the last war they relied on a variety of means for Communications, such as land-lines, visual signalling, etc.

Wireless was also used to a considerable extent. Land-line communication between various units was subject to interruption by shell fire, and parties were detailed for no other purpose than to keep the land-lines in repair.

Wireless is replacing land-lines to a considerable extent, although land-line communication in the present manœuvres still exists. This latter form of communication between Battalions and Brigade, and between Brigades and Division, etc., is in the control of the Army Corps of Signallers.

Mobility

Modern armies employ aeroplanes and tanks to a very large extent. With such mobile bodies it is obvious that the chief form of Communication must be wireless, although other forms of signalling are still made use of. Although these mobile units have their special functions to perform, they cannot act in all respects as independent units, and they must communicate with the more stationary units, and, further, they must communicate with each other. The Royal Air Force acts as the eyes of the Army, and it communicates directly with all units of the Army — infantry, artillery, cavalry and tanks.

WIRELESS MANO

By Major JAMES ROBL
Director of Resear

This special article will enable our
into wireless methods in the Serv
information regarding

Organisation

The magnitude of the organisation required is obtained from a perusal of the large list of lines of communication which are required. The Commander-in-Chief must have direct communication with his armies; these in turn must have direct communication with their corps and divisions, and divisions with brigades, who must be in touch with the battalions. The Royal Air Force must provide information for the Army, and this falls under various headings. For each respective duty the various squadrons, and sometimes various

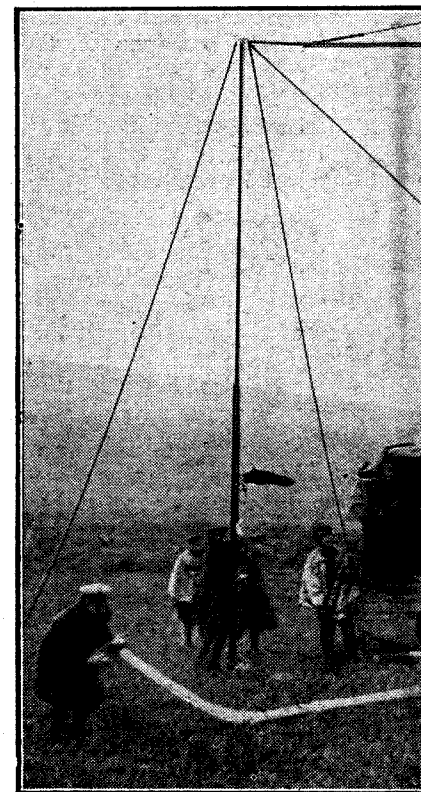

Erecting the masts and laying out the

IN THE ARMY MANŒUVRES

Dr. Robinson, D.Sc., Ph.D., F.Inst. P.,
to Radio Press, Ltd.

Readers will gain a most interesting insight
into the actual frequencies in use.

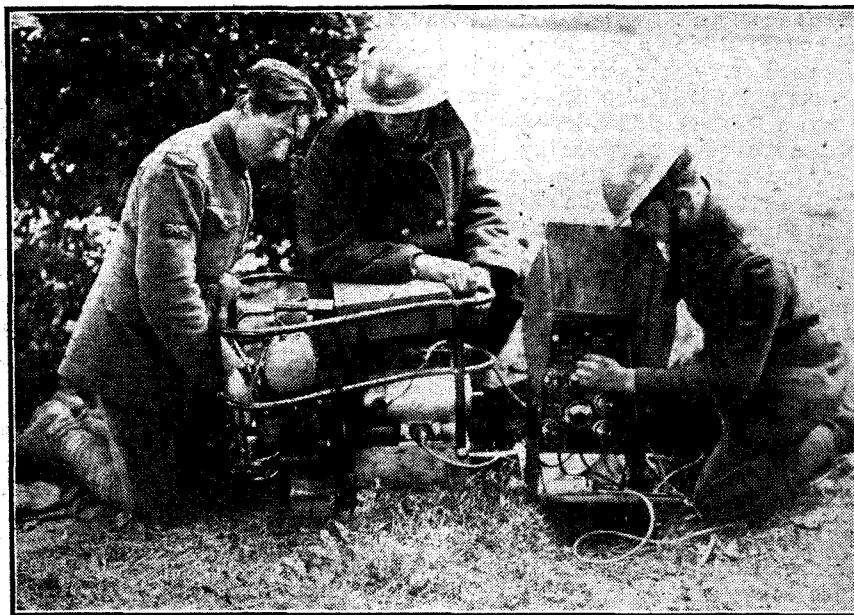

The generator and switchboard of one of the wireless sets used by personnel of the Royal Air Force.

flights, must have different lines of communication, *i.e.*, frequencies. Then, again, there is cross communication from the aircraft to the infantry, from the aircraft to the tanks, and from aircraft to artillery. Again, there is inter-communication inside the Royal Air Force. There is communication between squadron headquarters and the aeroplanes, and also there is communication inside the squadrons during flight. All these forms of communication are equivalent to different lines of communication. A huge organisation is therefore called for in order that each line of

communication shall be kept in perfect order. The efficiency of the Army as a whole depends vitally on the reliability of all these lines of communication; such a vast organisation is put to a very severe test in the Army Manœuvres. Different lines of communication are obtained by using different frequencies, and it is obvious that a very large number of frequencies is required in operations on the scope of the present manœuvres.

"Frequency" Replacing "Wavelength"?

It is interesting to note that our Services are tending towards the use of frequencies in place of wavelengths. In such a large organisation the convenience of using frequencies is very great.

Such a large number of frequencies is in demand that there is considerable crowding. The frequencies in use vary from about 4,000 kc. to about 100 kc., and in some regions of this frequency band there is such crowding that the frequencies are only $2\frac{1}{2}$ kc. apart. It is obvious that there must be a very great accuracy in adjustment of frequency to guarantee that these lines of communication will be reliable, and it is no easy matter to keep transmitters accurate within the limits given. This difference of $2\frac{1}{2}$ kc. makes it somewhat difficult to separate neighbouring trans-

missions by the heterodyne method of reception, even when both are accurate. A small deviation from the frequency of a number of stations may easily produce chaos.

Accuracy

In order to guarantee accuracy of adjustment of frequencies, the Air Ministry is sending out standard transmissions on different frequencies at different times of the day, and thus the various units can guarantee to have their wavemeters identical.

In the neighbourhood of 3,000 kc. (100 metres) the transmissions differ by about 200 kc. In the neighbourhood of 750 kc. (400 metres) the transmissions differ by no more than 7 kc. From about 270 kc. (1,100 metres) to about 140 kc. (2,200 metres) the lines of communication are so crowded that at times they are as close together as $2\frac{1}{2}$ kc. This is the band of frequencies which includes Daventry, which is on 187.4 kc. (1,600 metres), and we can thus understand the desire of the Services to curtail the activities of Daventry during the course of the manœuvres.

Apparatus Employed

Some details of the actual functions of wireless and the actual apparatus employed in the Manœuvres will be of interest. There are so many lines of communication re-



Earth mats for a mobile wireless station.

quired that it is necessary to use transmission of a form which absorbs as small a frequency band as possible. Thus spark transmission is not employed in any form. C.W. is used very considerably, and in some cases it is also necessary to use a form of transmission which will not require reception by means of the heterodyne method, and therefore reception must be obtained with apparatus which requires very little adjustment. The ideal form of transmission for this would naturally be spark, but as this creates so much jamming, tonic train or interrupted continuous wave is used instead. Naturally telephony requires some reference, as considerable use is being made of wireless telephony in the present manœuvres. Some reference is also required to direction finding, which is of immense importance in any war operations. One case in which it is being used is to enable aeroplanes to note their position definitely, and more particularly to enable them to find their way back home after their operations are completed.

As regards the Royal Air Force activities, these come under various headings.

Reconnaissance

It is necessary to find out immediately what the enemy is doing at some considerable distance behind the lines, say up to 100 miles. Reconnaissance aeroplanes fly to such distances, and any information of importance can be sent immediately to the base by means of wireless. For this purpose telegraphy is used, such aircraft usually carrying a wireless operator. Amongst the restrictions of aircraft are naturally the weight and space available, and the number of *personnel* that can be carried is very limited. A wireless operator on this type of aircraft has, in addition, other functions to perform; in fact, the general duties of an observer.

Apparatus on Aircraft

The apparatus carried on reconnaissance aircraft consists of a C.W. transmitter, consisting of two A valves in parallel. This transmitter is very much on the same form as that used in the War, which was called the type 57. Wavelengths from 1,000 to 2,500 metres may be employed. A trailing aerial is used, this aerial being let out by the operator by means of a suitable winch, usually to a length of 200 ft. Power for the transmitter is obtained from a

generator which is driven by means of a windmill. The generator is sometimes placed on the wing of the aeroplane and sometimes placed at the side of the fuselage. In the latter case it can be rotated on a vertical axis, so that the windmills get full on to the wind or sideways, in the latter case, of course, no voltage being possible. Any position between these two extremes can be obtained, and this naturally regulates the voltage obtained on the aeroplane. A fairly straightforward form of receiver is employed, using one high-frequency valve with reaction and two low-frequency amplifiers, the first valve also acting as detector.

Generally speaking, it is important to keep down the weight of apparatus carried on the aeroplane to a minimum. It is thus of the utmost importance to keep down the filament consumption of the valves, and thus low consumption valves are used.

Ground Station

A receiving station for working

more selectivity is introduced. The whole of this ground station is mobile, and this is installed in a lorry. Light masts are used, the earthing being provided by means of earth mats.

Communication with Infantry and Tanks

For this purpose telephony is used, and the telephony set has many points of interest. In the first place, it makes use of no trailing aerial. This is necessary because for communicating with the infantry, aircraft very often fly low and trailing aeriels would tend to be pulled off. The use of a fixed aerial on an aeroplane naturally restricts the wavelength which can be efficiently used, and thus the present telephony wavelengths are in the neighbourhood of 60 to 100 metres. The aerial may be of two forms. In some cases it is actually fixed inside the wing of the aeroplane. The position usually chosen for this is the trailing edge of either the upper or lower wing. In this case, however, a counterpoise is used of a similar type. For instance, the



An R.A.F. portable wireless station used for receiving signals from aeroplanes for the control of artillery.

with the reconnaissance aeroplane is usually with the squadron. This station employs a transmitter of about half a kilowatt. The transmitter is very similar to one of the first valve transmitters ever used, which was called the type 56B transmitter. It employs a 250-watt valve, with an anode voltage of 2,000. Reception is carried out by a form of receiver very similar to the aeroplane type, except that

wire on the trailing edge of the aeroplane may be the aerial, and that on the lower wing may be the counterpoise. Sometimes, however, better results can be obtained by the use of the metal work of the aeroplane as a counterpoise, and the type of aerial which is being used very considerably in the present manœuvres is stretched from the wing tips to the tail of the aeroplane. In this case, usually

the body of the machine is used as a counterpoise or earth. Considerable work is being done on fixed aeriols on aircraft by the Royal Air Force, and they have obtained remarkable results with this form of aerial.

A transmitter is used which consists of a control valve and two power valves, the whole consumption of power being less than 100 watts. The wavelength of the transmitter is variable on the range already indicated. The power for the transmitter is obtained in the former case from a wind-driven generator placed in the wing. A special form of receiver is employed on the aeroplane, which employs a number of valves, using up-to-date principles. Again, low consumption valves must be used in order to minimise weight of batteries.

Telephony

The problem of telephony on aircraft is not simple, the conditions being very much more rigorous than in the case of the British Broadcasting Co.'s transmitting stations. Space is restricted, there is a tremendous noise ever present, and, in addition, there is the noise produced from the magnetos of the engine, this magneto noise being really equivalent to that obtained from a number of spark transmitters a few feet from the receiver. The wavelength of the disturbance from the magneto is of the order of 5 to 30 metres, and thus it is not very different from that actually employed for communication purposes on this type of aircraft. The Royal Air Force has tackled this very serious problem of magneto interference and has obtained great success in its elimination.

Microphones

The microphone must receive special attention, for if this is left open or put in the wrong place the general noise of the aeroplane will actually be transmitted to the receiver on the ground or to another aeroplane. Thus it is necessary to guarantee that the rush of wind is kept away from the microphone, as well as the general engine noises.

Engine Noises

As regards reception, it is absolutely necessary to shut out all noises in order to hear signals which are coming through. An excellent form of helmet is used, which can enable all such noises to be eliminated. For telephony purposes it is usually not possible to carry a

wireless operator, and very often communication is required on single-seater aeroplanes. It is thus necessary to arrange for the pilot to perform the transmission and reception. This, again, introduces difficulties, such as training the pilot to speak properly, and designing the apparatus in such a form that it can be operated by a person with little or no knowledge of wireless. Another feature is that it is necessary to place the transmitter and receiver out of the reach of the pilot, for he has many other instruments to deal with in addition to the wireless instrument, and there is very little space in his cockpit.

Remote Control

A form of remote control is employed which gives great satisfaction. This control gives similar

found to be of great use, for it enables the General Staff to obtain very early information of enemy activities at comparatively close distances up to 10 and 20 miles. In this case some member of the General Staff can actually be in telephonic communication with the aeroplane which is flying over the enemy's lines.

Intercommunication between Aeroplanes

Telephony is also used for this purpose. The Squadron Commander is able to give orders to all his pilots, and can thus easily control his whole squadron. A demonstration of this form of squadron control was given at the last Aerial Display at Hendon, when a squadron of the Royal Air Force was put through a number of evolutions by wireless telephony controls.

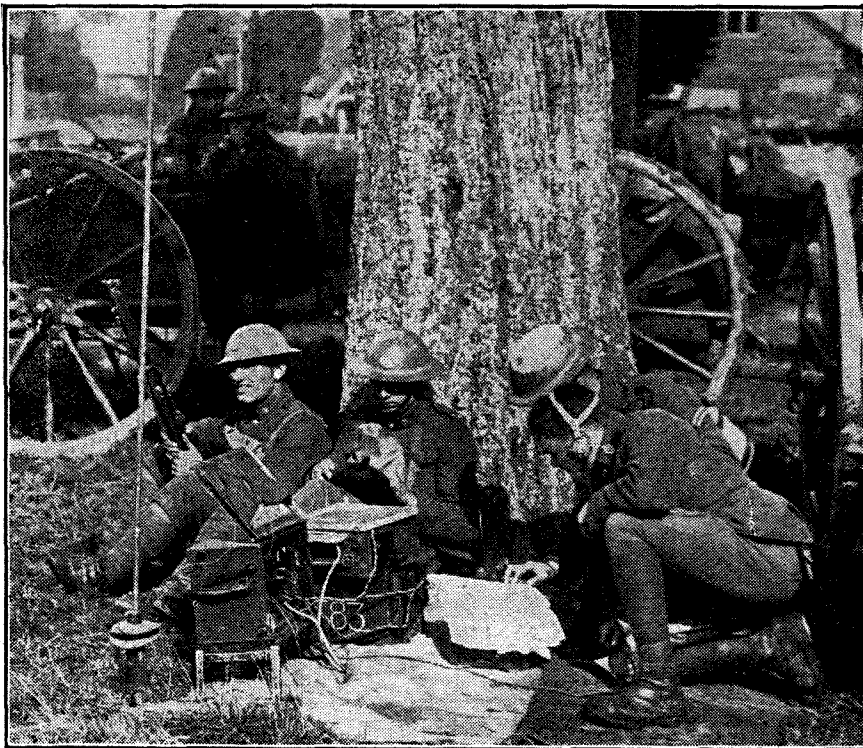

A typical Army portable station which can be very speedily erected and dismantled

results to the Bowden wire control, but is actually different from the Bowden wire principle.

Close Reconnaissance

In addition to the lines of communication with infantry and tanks, telephony is used on aircraft for close reconnaissance work, and communication is kept up by telephony with the base. The base station is usually mobile, and contains similar apparatus to that on the aeroplanes, but in this case being installed on a tender. This form of communication is being

Developments

The good results being obtained with telephony in the Army and the Royal Air Force is a result of a number of years' training and development. Telephony over fairly long ranges from air to ground and vice versa, and between aeroplanes has been done for a number of years, but it is one thing to give demonstrations on one or two aeroplanes and quite another to have efficient operation with large numbers of aeroplanes.

(To be concluded.)

CONSTRUCTIONAL NOTES

Some items of general interest to the home constructor will be found on this page.

Shortening a Honeycomb Coil



It sometimes happens that a honeycomb coil of standard size is a little too large to suit a particular circuit.

On one of my sets, for example, with the tuning condensers in use a No. 75 coil is just too large to allow the closed circuits to be tuned down to 300 metres, whilst at the other end of the scale it will tune to a good deal beyond the ordinary broadcast wavelengths. As it is rather a nuisance to have to change inductances when one is trying round for various stations the simplest method is to reduce the 75 coil by a few turns.

The first thing to do is to separate the coil from its plug-and-socket mounting, taking care not to damage the connection of the end of the wire to the plug. Should the coil be wrapped with Empire tape this must be removed carefully. Now unwind two or three turns from the end of the wire which will be found attached to the socket. Cut off, bare the end, and make a temporary attachment to the socket by means of the screw which secures it to the ebonite block of the mounting. Test the coil on the set to see what effect the reduction has upon the maximum and minimum wavelengths obtainable. Proceed in this way, unwinding a few turns at a time and testing after each operation, until the required range is reached. Then solder the "out"

end of the windings to the socket and refix the coil securely to its mounting, replacing the Empire tape binding if this is used.

If necessary the wires can be secured temporarily whilst tests are being made by means of a small piece of sticking plaster. R. W. H.

An Effective Aerial Insulator

The glass tubes sold as towel rails can be used as very efficient aerial insulators. They are very light and quite suitable for a single wire aerial, provided they are properly attached.

If they are just tied in, as shown in Fig. 1, they will be subjected to an uneven strain and are likely to be broken.

The best way to fit them is as follows: Prepare the ends of the

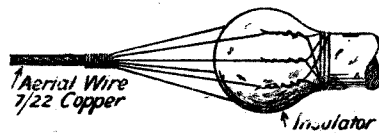
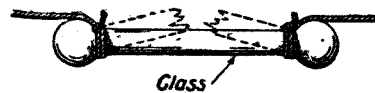

Fig. 1. The method of securing the wire to the insulator shown in the lower diagram will prevent breakage.

7/22 aerial wire by putting a seizing on it about 8 in. from the end, then unstrand the wire down to the seizing and remove the central core wire. The six outer wires should

then be fanned out and fastened, one at a time, around the neck of the insulator, as in Fig. 1 (top), taking care to make them all the same length.

The knot securing the halliard to the other end of the insulator should be made as in Fig. 1 (bottom). The loops should be made by eye-splicing or by knots. The head of the insulator is placed through the hole A and the three loops drawn tight so as to space the tails evenly. If

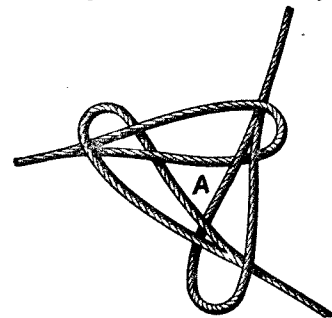
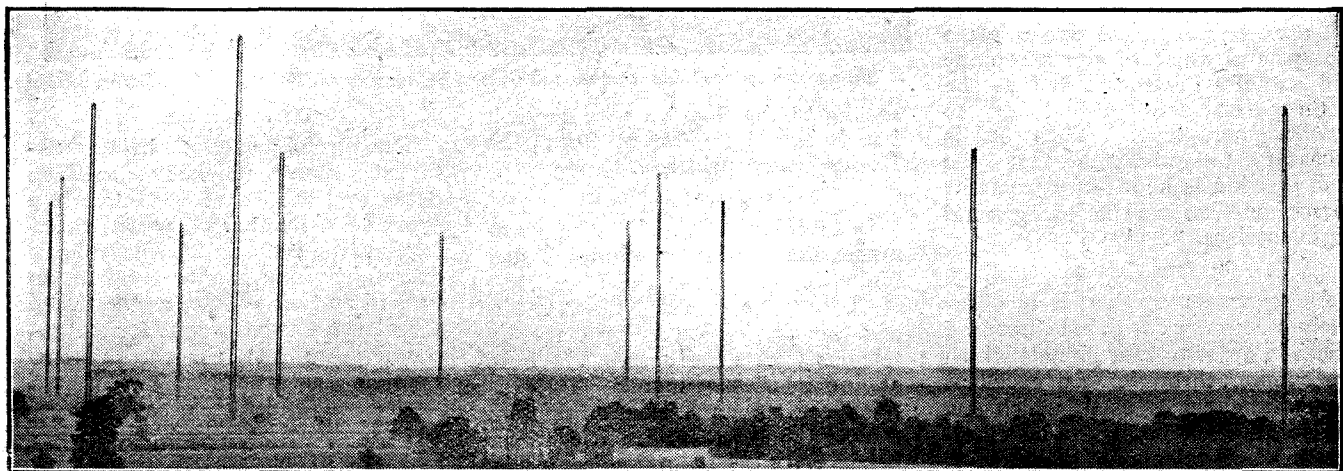

Fig. 2. Showing how the loops for securing the insulators are formed.

these are made of thick string, they should be knotted together and made fast to the halliard.

Care should be taken in erecting, as these glass tubes are very brittle, but they will take a great strain if they are attached in this manner. As they are about 18 in. long their electrostatic capacity is small, and this is further reduced by their hollowness. (The towel rails referred to can be obtained quite cheaply from Woolworth's Stores.)

H. W. P.



The twelve aerial masts of the Government wireless station at Hillmorton, near Rugby, are each 800 feet high.

A HOME-MADE TAP FOR EBONITE

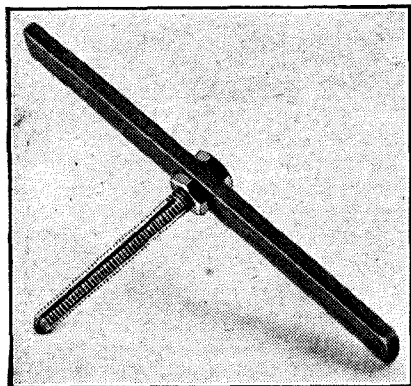

The tap described in the accompanying article may be mounted in a strip of brass as shown.

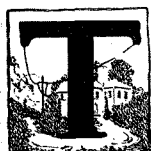

HERE are, no doubt, many amateurs who do not possess a tap among their kit of tools. In some cases it may be a question of expense that stops amateurs from purchasing these, or, in other cases, there may be so little use for them that it does not seem worth while getting one. A very satisfactory tap, however, for cutting threads in ebonite can easily be made from a piece of screwed brass rod or studding; and that shown in the illustration was from this material. The 2 BA and 4 BA sizes can be made without much difficulty, but if one is to be made out of 6 BA a certain amount of skill is required.

Holding the Rod

The procedure to be adopted in making the tap shown is as follows. A short length of screwed rod of the required gauge is fixed in such a manner that it is firmly held. This may be done either in a vice, in which case jaw-guards should be used so as not to damage the thread, or on the edge of the bench, by clamping a piece of wood on top of it. A small slotting file or some other small sharp-edged file is then used to cut a slot lengthwise in the threaded rod.

Filing the Slots

The one edge of this slot, which is the cutting edge, should be along the radius of the rod, while the other is filed away to give the necessary clearance, as shown in the sketch. Three slots are cut in this manner, spaced equally round

Taps for thread-cutting in ebonite are an almost essential part of the constructor's tool-kit, and taps for this purpose of any required size can be made with the aid of a small file only, as described in this article.

the circumference of the rod, and care should be taken that the slots are large enough and deep enough to accommodate the ebonite dust resulting from the cutting action.

Spacing of Slots

Care should be exercised in cutting these slots, otherwise they may be unequally spaced, which spoils the appearance of the tool (although without actually affecting its efficiency to any material extent), but chiefly so that the cutting edge be correctly set, otherwise it may be found that the tap will not cut easily, and requires a certain amount of force to use.

Cleaning Up

Having completed the cutting of the slots, a nut may be run round

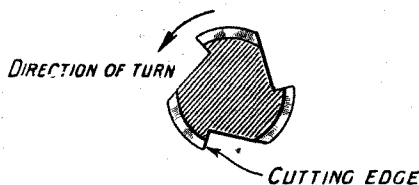

Fig. 1.—Careful setting of the angle of the cutting edges will ensure an efficient tool.

to remove any burrs that may have been left on the edges of the thread by the file.

It should be noted that when cutting the slot with the point of the threaded rod towards you, the right-hand edge of the slot will be the cutting edge, the left-hand one being filed down to give the clearance. If this point is not observed the tap will not, of course, cut.

The Holder

The next step is to make the holder for the tap, and this may easily be made from a piece of flat brass strip. A suitable size for this brass strip is $\frac{3}{8}$ in. wide by $\frac{1}{8}$ in. thick and 4 ins. in length. A hole is drilled in the centre which will just clear the size of rod being used, which is next cut to the required length. It is then fixed into the holder by means of two lock nuts on each side of the strip of brass. These nuts are tightened

up as far as possible, and may be locked in position either by putting a number of centre-punch marks in the angle formed between them and the screwed rod, or by running solder around so as to set the nuts solid.

C. P. A.

A Cheap Transmitting Milliammeter

THE question of meters is a serious one for the amateur transmitter with a limited purse, and, though second-hand aerial meters of the hot wire type can be picked up cheaply enough at certain disposals shops, a plate milliammeter reading up to 100 milliamps or so is not so easily or cheaply obtained.

A Good Substitute

An excellent substitute is, however, to be found in one of the cheap low-resistance voltmeters that are now everywhere on the market. An instrument of this description reading up to 10 volts may be obtained for five or six shillings, and has only a resistance of about 200 ohms, a negligible resistance when placed in the plate circuit of a transmitting valve being supplied with 200 volts and upwards.

Calibration

A meter purchased by the writer was found to register 10 volts in this position when about 100 milliamps was being passed, and it was calibrated against a milliammeter which was known to be fairly accurate. A calibration curve was plotted, and from this another scale was made and pasted over the volts scale of the meter. Accurate reading could not be obtained below about 8 milliamps, but a very fair idea of the plate current being passed was obtainable. Being of the flush-mounting type, its appearance is quite neat, while its small cost recommends it to the amateur who does not mind obtaining readings that are not accurate within a few per cent.

P. A. G.

EXTENDING THE BROADCAST RANGE

(Continued from page 40.)

Capacity Ratio of Condenser

The condenser used in preparing this table had a maximum capacity of $500 \mu\mu\text{F}$, and we cannot count on a minimum lower than about $25 \mu\mu\text{F}$, because of the wiring, etc. Furthermore, it is not well to use the condenser at the very low dial settings, as it is very inefficient at these points. The resistance of a condenser increases to very high values at the low dial settings.

The capacity ratio was, therefore, $500/25$ or 20 to 1. It is very interesting to note that, although we require a capacity ratio of 9 to 1 to cover the 600-200-metre range, and although we have condensers having capacity ratios of 20 to 1, still many have not been able to cover the range completely. It is quite a mystery to the writer why this has been so difficult. He has constructed many radio receivers, and has not had any difficulty at all in covering the total broadcasting range.

But to deal with the range of 600-150 metres we should have to keep things in the same proportion. So, if we could cover the range 600-200 with a 20 to 1 condenser, requiring only a 9 to 1 ratio, then to cover

a range 600-150, requiring a capacity ratio of 16 to 1, which is about twice the 9 to 1 ratio, we should have to have a capacity ratio of about twice 20 to 1, or 40 to 1. This high capacity ratio is not obtainable in the small-sized condenser. A $0.001 \mu\text{F}$ condenser may fill the bill, however, for this can be counted on to have a capacity ratio of at least 40 to 1. Thus, a condenser having a maximum of $1,000 \mu\mu\text{F}$ and a minimum of 25 will have a capacity ratio of $1,000/25$ or 40 to 1.

Another Difficulty

There will be difficulties involved here, however, which will make it necessary to go to other means of extending the range. The main difficulty lies in the great congestion of stations which will be found on the lower half of the condenser dial. Besides this, it will be difficult to tune the set sharply, as everyone knows who has tried to tune with large condensers.

We come to the end of our journey, therefore, with the tentative conclusion that the difficulty is perhaps most satisfactorily overcome by the use of tapped coils in the tuned circuits. Of course, it is not entirely necessary to use three ranges. Two ranges will be satisfactory for most purposes; but the advantage of spreading out the stations as much as practicable is, of course, the elimination of crowding.

Much ingenuity will have to be exercised in keeping down the number of switches and controls. But difficulties such as this will be overcome, for there is scarcely anything for which a suitable switch cannot be designed.

THE INTERFERENCE PROBLEM

(Continued from page 43.)

ful local station was cut out almost completely all over the scale, and the intense belts of arc mush which normally make DX reception practically impossible here for long periods every day were reduced to a moderately noisy background only.

By loosening still further the coupling by tapping at the 15th or 10th primary turn, London was cut out by one filter stage on Manchester and Cardiff. With two separate filter-stages the local station had to be searched for; mush had almost vanished, and both Manchester and Cardiff could be obtained at any loud-speaker strength required completely free from London, but subject, of course, to the usual mush-to-signal-ratio rule, and to parasitic L.F. interferences.

Signal strength diminished perceptibly with two filter-stages in use, but not prohibitively; it could be readily compensated for by silent L.F. amplification, and was more than made up for by freedom from the arc mush. Provided that sensitive and uniform reaction control was available, the tuning was quite

simple once calibrations had been obtained by means of a wavemeter for each tuning-point. With the addition of two stages of transformer-coupled power L.F. amplification, a receiver was obtained on which it was not difficult to go the round of a number of distant stations without using headphones at

all, and that within a few miles of powerful interfering stations.

It is possible that at very short distances from a broadcasting station special care will have to be taken to avoid direct pick-up by the filter-unit inductances themselves. This effect was not noticeable at 12 miles.

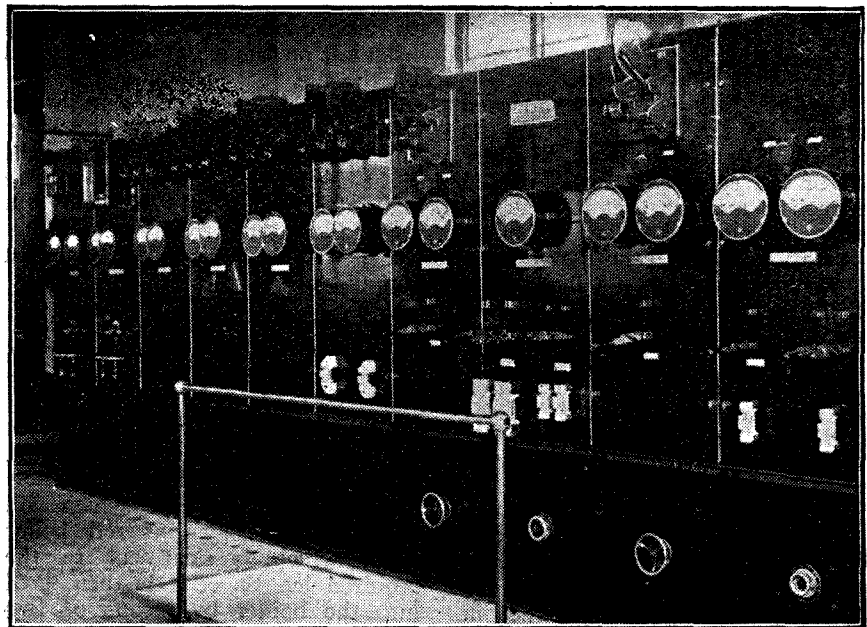

The switchboard in the power-house at the Post Office Wireless Station at Northolt, which deals with general Continental traffic.

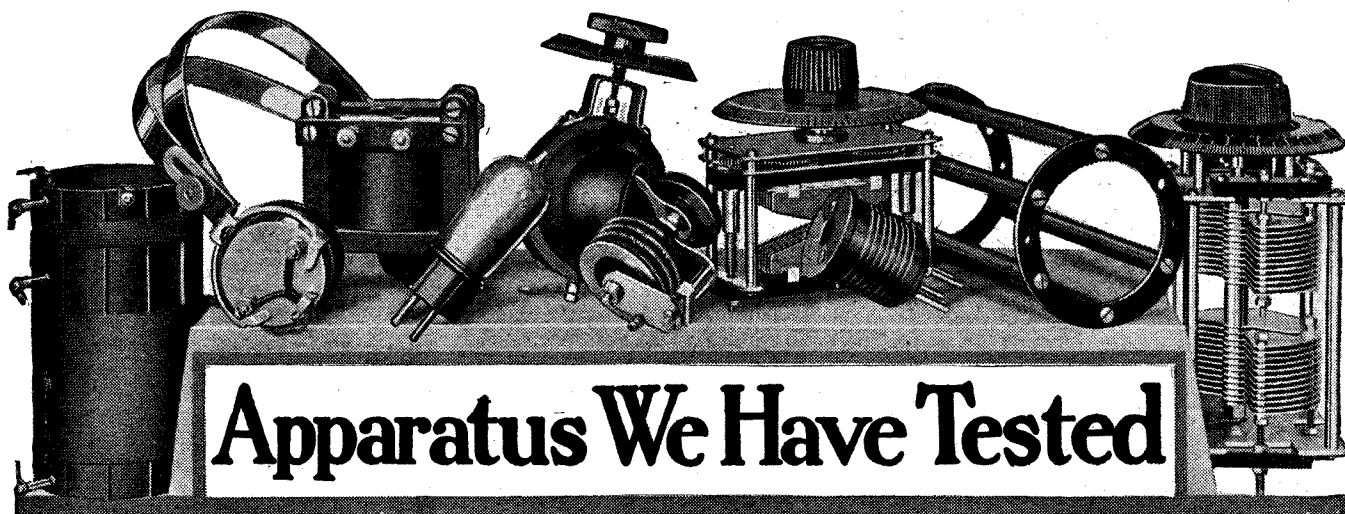

Conducted by A. D. COWPER, M.Sc., Staff Editor.

"660" Valve

An interesting valve which is fitted with a thorium-coated molybdenum filament, in place of the usual thoriated tungsten, has been submitted by Messrs. The Electron Co., Ltd. This is of the 2-volt D.E. class, the rating being given (in the usual vague and rather unhelpful manner) by the makers as 1.5 to 2 volts filament voltage and 30 to 100 volts for H.T. requirements. Structurally the valve follows conventional lines, with a nearly vertical cylindrical anode of fair size and a somewhat open spiral grid.

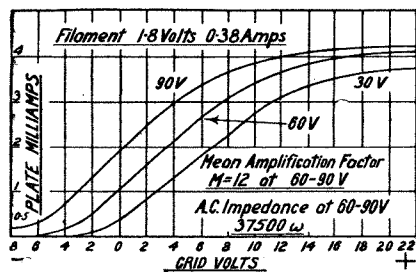

Fig. 1.—Characteristic curves of the "660" valve.

The valve has a cylindrical bulb and is about 3 in. high; the base is made of a mottled red insulating material.

On trial, a fair emission of 1.8 milliamperes was registered with high plate potential and positive grid bias when 1.5 volts were applied to the filament; with 1.8 volts this emission increased to 5 milliamperes, and at 1.9 volts on the filament to 7 milliamperes. Accordingly the characteristics were determined with 1.8 volts, at which rating the filament took about .38 amperes. The curves showed a power to handle considerable energy without departing from a straight characteristic, with 90 volts or more of H.T.; a 4-volt swing was permissible on 90 volts, corresponding to a moderate degree of loud-speaking without dis-

ortion from overrunning the valve when used as last-stage L.F. amplifier. On practical trial this was found to be the case, and with 120 volts H.T. and 4 volts negative grid-bias quite a deal of power could be handled. The grid-current characteristic showed a very rapid rise about .5 volts positive; with a low value of H.T. and a high grid-leak (4 megohms) excellent detection resulted on weak signals. The very satisfactory mean amplification factor of 12 found was consistent with this; the A.C. impedance was moderate, about 37,500 ohms in the 60-90 volt region. In H.F. amplification the valve operated normally, but oscillated with considerable ease, so precautions had to be insisted on for ensuring stability. The valve in general showed itself to be a useful general-purpose one, with special merit as a detector for critical work.

Silvertown Verniometer

A slow-motion fine adjustment device which can be applied to existing condenser and variometer spindles without elaborate alterations is the "Verniometer," a sample of which has been submitted by Messrs. The Silvertown Co. This consists of what at first appears to be an ordinary bevel scale 3 in. in diameter, which can be affixed on a $\frac{1}{4}$ -in. plain spindle by means of a set-screw. But it is noticed that the base of this scale is a brass plate, around the periphery of which is cut a worm-wheel; with this engages, when required, a fine screw-worm on a tangential spindle 4 in. long, mounted in bearings on a small bracket to be fixed on the panel by two small screws. This spindle has a controlling knob, and has also a circular scale on it for fine settings. An ingenious mechanism enables this fine-adjustment device to be swung out of engagement when doing preliminary rough tuning or searching. On trial, the control was found to be fine enough for any reasonable purpose, and the mechanism operated smoothly. A de-

sirable refinement, which would not be a difficult matter to install, would be the provision of a non-conducting spindle for the fine adjustment or equivalent isolation for hand-capacity effects at some other point; there is a complete metallic connection from the condenser, etc., spindle to the spindle under the small fine-adjustment knob at present.

Hales Aerial Control

Messrs. The Wholesale Wireless Co. have sent in a sample of their "Hales Aerial Control" and "Lead-in Control." The former consists of a strong spiral spring about 5 in. long, fitted with an insulator at each end. This is intended to be introduced between the end of the aerial wire itself and the halliard. Under ordinary conditions it is a difficult matter to maintain an aerial taut, on account of the expansion and contraction of the wire and halliards with temperature and moisture, and of the swaying of the poles in the wind; the result is a certain loss of effective height, and often a periodic fading due to alterations of tuning through the varying aerial capacity resulting. The "Aerial Control" appears to possess the right degree of springiness to counteract this effect, enabling the aerial to be pulled up taut at all times, and providing at the same time a sufficient degree of "give" to allow for these variations in length without unduly straining masts or halliards.

The lead-in control, consisting of a similar spiral of phosphor bronze 2 in. long, is designed to keep the lead-in wire taut. A spring eye is provided to fix on the end of the lead-in fitting and acts as an automatic locking device here; the main spring comes at the end of a bent arm, which supplies, at its lowest point, a drainer for rain water running down the lead and helps to maintain the lead-in insulator dry. These devices should certainly add to the appearance and practical efficiency of an outside aerial system.

(Continued on page 64)

CORRESPONDENCE

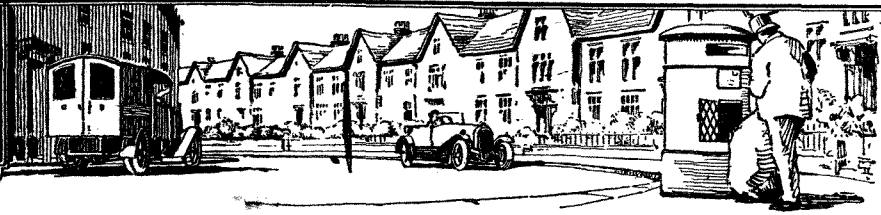

THE THREE-VALVE DUAL RECEIVER

SIR,—I herewith enclose you a small and, I am afraid, a rather poor photograph of my "Three-Valve Dual Receiver" (*Modern Wireless*, April, 1924, by John Scott-Taggart, M.C., F.Inst.P., A.M.I.E.E.) This set has given great pleasure to myself and many others.

I am able to go round all the main English and as many foreign stations. Simply by tuning with the loud-speaker all stations come through at full loud-speaker strength, and I have yet to find a straight four-valve circuit that can equal it for volume and purity.

I have wired the set with bare square section wire, but the components used are as specified by Mr. Scott-Taggart.

With sincere thanks for publishing such an excellent circuit.—Yours faithfully,

C. A. BIRTWHISTLE.
Weston-super-Mare.

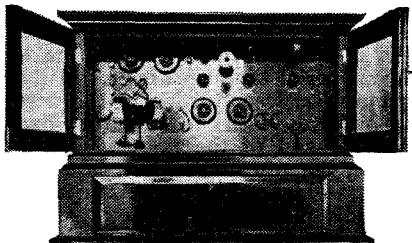

The handsome 3-Valve Dual Receiver built by Mr. Birtwhistle.

THE NINE-VALVE SUPER-HETERODYNE

SIR,—I have constructed the "Nine-Valve Super-heterodyne" set described by John Scott-Taggart, M.C., F.Inst.P., A.M.I.E.E., in the May issue of *Modern Wireless*, and want to tell you that I am exceedingly satisfied with it. It is certainly the best set I have ever had, although I have already constructed about 30 different sets with a number of valves varying from 2 to 11. I have received the following stations at full loud-speaker strength on a very small frame in a house surrounded by steel concrete buildings, with lots of iron machinery in them:—Berlin, Breslau, Vienna, Zurich, Aberdeen, Toulouse, Rome, Hanover, Dresden. These results

were obtained whilst the local station, Nuremberg, about a third of a mile from my house, was working with an output of about 1 kw., without any interference.

Thinking that this statement might be of some interest to you, I wish to remain,—Yours faithfully,

K. NISTER.

Nuremberg.

A TWO-VALVE DOUBLE REACTION RECEIVER

SIR,—Knowing that letters of appreciation are always welcome, I feel that I ought to let you know how satisfied I am with the "Two-Valve Double Reaction Receiver" published in the August issue of *The Wireless Constructor*, by Stanley G. Rattee, M.I.R.E. I built this set recently, not with the components given, but with equally good ones. I have up to date logged the following stations (all at good strength):—Newcastle (very loud), Leeds and Bradford, Bournemouth, 2LO, Cardiff, Aberdeen, Hull, Manchester, Dundee, Glasgow, Edinburgh, Belfast, Liverpool, Frankfurt and two other German stations unidentified, Oslo, Radio Toulouse, Radio Paris, Radio St. Sebastian, E.A.J.8 testing. I can get this last station each evening at 11.30 p.m., 300 metres. WGY testing on September 8, 11.45 p.m. Daventry comes in on loud-speaker quite well. I have a Louden 6-volt F.E.R.1 dull emitter and a B.T.H. B4 power valve as the second. I have had all stations several times excepting WGY once only, Oslo twice, Belfast once, Liverpool once. I have a "Family" four-valve set as well, and, strange to say, I cannot touch some of these stations with it.—Yours faithfully,

H. LEWIS.

Scarborough.

THE "TWIN-VALVE" RECEIVER

SIR,—I think you may be interested to hear of my experience of Mr. Scott-Taggart's "Twin-Valve" Receiver, described in the January issue of *The Wireless Constructor* and Radio Press Envelope No. 10. I have built this set twice, but I have been unable to tune down to the Sheffield station's wavelength (301 metres), the .0003 μ F variable condenser being at zero for Manchester (378 metres). By follow-

ing the instructions of the makers of my H.F. transformers and tuning the primary winding instead of the secondary winding with the .0003 μ F variable condenser I was enabled to tune Sheffield and other relay stations at excellent loud-speaker strength.

Trusting my experience may be of value to some other experimenters similarly perplexed, and wishing you every success.—Yours faithfully,

EDGAR H. RIDGWAY.

Rotherham, Yorks.

THE OMNI RECEIVER

SIR,—Please find enclosed a photograph of my "Omni" Receiver, which I constructed soon after it was published in *Modern Wireless* (January, 1924, issue, by John Scott-Taggart, M.C., F.Inst.P., A.M.I.E.E.) and *Wireless Weekly* (Vol. 3, No. 4, and subsequent issues).

I have spent many hours experimenting with the set, trying out

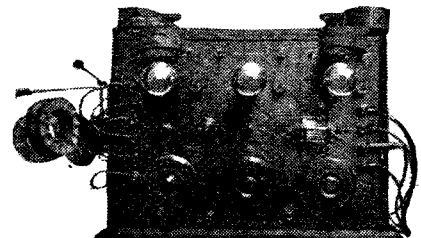

The Omni Receiver which, together with the coils, was constructed by Mr. Brett.

various circuits, and I have learnt much from *Wireless Weekly* and *Modern Wireless* with the aid of my "Omni."

All coils are of my own construction, again due to the tuition gained by being a regular reader of Radio Press publications from No. 1.

Wishing you further success.—Yours faithfully,

S. J. BRETT.

Clapton, E.5.

ENVELOPE NO. 3

SIR,—You are almost sure to have received more communications concerning your "Simplicity" set than are pleasant to deal with. Yet the remarkable results, in my humble

opinion, prompt me to express at least my thanks for the assistance of Envelope No. 3 (by G. P. Kendall, B.Sc.), in making up this set for a customer.

My customer insisted on provision of space for the addition of a fourth valve. I tried to dissuade him in vain. I assured him he would not require same. But I made the panel 10in. x 18in. instead of 10in. x 14in., and did not alter the general arrangement otherwise.

Tinned square copper wire was used for wiring, and all joints were soldered.

The list of stations heard so far includes Daventry, London, Bournemouth, Toulouse, Munich, Madrid, Eiffel Tower, Breslau, Petit-Parisien, Cardiff, Barcelona, Dortmund, Radio Paris, Oslo, Zurich, Cadiz, Birmingham, Aberdeen and Danzig.

The aerial used is a twin wire in the loft of the house underneath the roof, and is about 35ft. high and 42ft. long.

The ease with which I "picked up" the various stations mentioned surprised me—and my customer. A loud-speaker has not yet been tried.—Yours faithfully,

ERNEST F. HOLDEN.

Folkestone.

AN ST100 RECEIVER

SIR,—I am sure it would greatly interest you to hear of my results using your ST100 circuit. I took the diagram from your handbook, "More Practical Valve Circuits (Radio Press Books, No. 15, by John Scott-Taggart, M.C., F.Inst.P., A.M.I.E.E.), and chose my own components, including Cossor Wuncell valves and basket coils for tuning. My aerial is a single wire, 35ft. long, 20ft. high and screened at one end. To begin with 2LO, this is too strong for my loud-speaker, and has to be detuned, using 80 volts on the plate. Just a little less in volume is 5XX. Birmingham, Newcastle and Bournemouth usually come in on the loud-speaker comfortable enough to hear, the rest of B.B.C. stations, except Belfast, being very good on 'phones. Relay stations picked up at fair 'phone strength include Nottingham, Bradford, Plymouth, Liverpool, Dundee and Hull.

These, however, are less consistent than the main stations.

Coming to Continental stations, results are even more gratifying, Radio-Paris being quite easy to get on the loud-speaker, as one should expect from their power. To be brief, my list is as follows, and they are most consistent:—Voxhaus, Radio Belge, Radio Iberica, Petit-Parisien, Stuttgart, Bremen, Ecole Superieure, Hilversum, Breslau, Rome, Radio Toulouse, Zurich, Hamburg, and others that I have not been able to recognise. Many of these have been heard very often at fair loud-speaker strength, but all of them are regularly good 'phone strength. I may add that most of these are heard on Sundays between 2LO hours. Regarding the

selectivity of this set, I use no wave trap, and, as you will see, I am not far from 2LO, yet on certain spots of the crystal I can cut them out and receive Birmingham and Radio Belge without a whisper from London, but only below and above those wavelengths. This must be undoubtedly the best two-valve reflex yet. I have tried numerous two- and three-valve circuits, but they did nothing near so great. Last winter I worked the ST100, but not this particular set, and I heard WGY on three or four occasions, and this year I hope to do better. To sum up the set, it is economical, it is consistent, though I always read the reverse of reflex circuits, it is a range getter and a powerful set. I feel so satisfied that I haven't troubled since to try any more circuits out. I am even doubtful whether the new ST100 would give me my present results.—Yours faithfully,

G. WARNER.

London, S.E.17.

A READER IN AUSTRALIA

SIR,—I would like to tell you of the great interest with which I have followed the description of the nine-valve supersonic heterodyne receiver in the May and June issues of *Modern Wireless*, by John Scott-Taggart, M.C., F.Inst.P., A.M.I.E.E. In the very near future I am going to try my hand at constructing this set, for I believe it will go far towards a solution of two of the great problems here, viz., selectivity and distance.

Another of our troubles is "Static" with a capital "S." It is truly terrible during the summer months, and quite often very bad even in the depth of winter, if it is desired to listen to any but the home station (supposing always that the listener-in dwells in a capital city), the shortest distance between any two broadcasting stations on the Continent being at least 300 miles, and no relays are employed.

Take, for example, the State of Queensland. The only station in operation is in Brisbane, in the S.E. corner, and this has to supply programmes as far away as proves to be possible. At frequent intervals, in cold weather, the writer has heard X's so bad that they completely obliterated all signals from a 5K.W. station 60 miles away for half an hour on end, except perhaps for a word here and there to show that the station was still working.

Still another of our problems is the wide wave band employed by our stations. One station in N.S.W. operates on 1,100 metres, and one in W.A. somewhere about the same wavelength, while the remaining five stations in the Commonwealth use wavelengths varying from 350-450 metres. This makes it very difficult to construct a set with other than plug-in coils to cover the range, and yet to be sufficiently selective to tune through the local station and pick up a distant one near the same wavelength. We are looking forward with interest out

here to the articles to be written by Mr. Harris on his return from U.S.A. and Canada, as we believe that some of the conditions prevailing in those countries will apply here, especially those pertaining to the West Coast of America and the Southern States.

I would take this opportunity of thanking you for the valuable information published in your very excellent papers, and would crave pardon for having taken so much of your time with my woes.—Yours faithfully,

ALAN S. QUARFE.

Brisbane.

THE TRANSATLANTIC IV

SIR,—I am just writing to let you know how well our "Transatlantic IV" is working (*Modern Wireless*, November, 1924, by Percy W. Harris, M.I.R.E.). I get all the main British stations and most of the relays. Also Ecole Superieure, an unidentified French station, Oslo (Norway), Rome, Madrid, Munich and Munster at loud-speaker strength.—Yours faithfully,

A. B. DICK.

Alvechurch, Worcs.

MAIDSTONE RADIO WEEK

SIR,—I hope that the following announcement may be of interest to your readers.—Yours faithfully,

H. T. COGGER.

Maidstone's Third Annual Wireless Exhibition will be held in the Concert Hall, Corn Exchange, and will be opened by G. Foster Clark, Esq., J.P., on Tuesday, October 13, at 6.45 p.m., and will continue until October 17.

Organised by the Maidstone and District Radio Society, the Exhibition promises to be a very successful event. An attractive programme has been arranged, and includes lectures by the B.B.C., the R.S.G.B., a Dance, a Concert in aid of the Maidstone Hospitals, wireless installation and an open competition for the best home constructed crystal to three-valve set. Entry forms for this competition may be obtained from the Hon. Secretary. All entries close on October 8.

An imposing display of all up-to-date apparatus and accessories will be on view at the stand of the most prominent wireless firms of Maidstone, and demonstrations will be given by them each evening. There will also be a good display of amateur work.

Further particulars may be obtained from the Hon. Secretary, Mr. H. T. Cogger, 44, Postley Road, Maidstone.

BOLTON AND DISTRICT RADIO SOCIETY

SIR,—I enclose a report with reference to a forthcoming event arranged by the above Society, which I hope may be of interest to some of your readers.—Yours faithfully,

N. ISHERWOOD.

A grand lantern lecture will be given on Wednesday, October 14, 1925, in the Y.M.C.A. Buildings, Deansgate,

Bolton, by H. A. Hankey, Esq., Assistant Chief Engineer of the B.B.C., London. Subject: "Radio Ramifications." His Worship the Mayor of Bolton (Councillor J. F. Steele, Esq., J.P.) will preside, and Victor Smythe, Esq. ("Uncle Victor" of 2ZY) will be present in support. Commence 7.30 p.m.

Hon. Sec.: J. GRIMSHAW, 70, Church Road, Bolton.

THE B.B.C. AND THEIR WAVELENGTHS

SIR,—May I congratulate you on your exposure of the B.B.C.'s laxity in regard to its station's wavelengths? We have always taken for granted that a great semi-official company such as the B.B.C. would be scrupulously exact in all matters relating to its broadcast transmissions. The plea of inefficient apparatus cannot—or should not—be advanced, since the Company's balance sheet for last year indicates large financial resources.

Dr. Robinson's disclosures serve to explain a matter which has been causing me some uneasiness, and which doubtless affects other readers of *Wireless Weekly*. I possess a heterodyne wavemeter, whose accuracy is guaranteed to $\frac{1}{2}$ metre. A couple of months ago, being interested in the proposed new wavelengths, I decided to devote some time to experimenting with my wavemeter.

Greatly to my surprise, I found that on tuning to 365 metres with the aid of the wavemeter 2LO could not be found on that wavelength, but was apparently transmitting on one several metres lower. Certain other stations gave similar—though not so pronounced—results, Manchester being a bad offender. Not unnaturally I blamed my wavemeter, thinking the transmissions themselves above reproach.

The matter is now explained by the article in No. 1 of *Wireless* and Dr.

should be connected with technical inaccuracies is little short of scandalous, and it is, in a way, fortunate that the matter has been brought to light by a British scientist rather than by a foreign listener.

I earnestly hope that the Radio Press, Ltd., will thrash out the matter with the B.B.C., and that the Elstree laboratories will continue to investigate such matters of public interest.—Yours faithfully,

G. V. LARKIN.

September 24, 1925.

TRANSATLANTIC V

SIR,—I think that you may like to have a report on my "Transatlantic V" Receiver (by Percy W. Harris, M.I.R.E., in *Modern Wireless* for June, 1924). This I have now had installed in regular use for some months, and I must say that I am extremely pleased with the results obtained.

I made up the set as described by Mr. Harris, and I am using home-made coils. My aerial is rather badly screened, and has an effective height of only about 20 feet, the earth lead being taken to a water pipe in the usual way.

I had America several times early this year, but have not done much in that direction lately. KDKA and WGY came in at wonderful strength, using the five valves.

Using three, or sometimes four, valves I can go the round of most of the Continental stations, loud-speaker results being obtainable from many of

APPARATUS TESTED

(Continued from page 61.)

"C.A.C." Valves

Samples of the "C.A.C." bright-emitter general-purpose valve have been submitted by Messrs. C.A.C. (Radio), Ltd., and have been subjected to an extended test. The construction is of the standard type associated with the R valve, with an unusually open spiral grid. It was to be expected, therefore, that the valves would display a small amplification-factor and a low impedance; this was confirmed on test. 3.5 volts appeared to be ample on the filament, the three specimens submitted showing a satura-

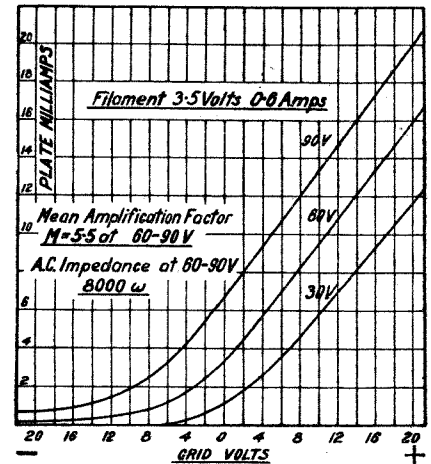

The characteristic curves of the C.A.C. valves submitted for test.

tion current at this rating of 13, 14 and 23 milliamperes respectively, with ample H.T. and positive grid bias. The current taken was between .55 and .6 amperes with 3.5 volts on the filament. The characteristic curves gave a mean amplification factor of but 5.5, with the low mean A.C. impedance of 8,000 ohms, corresponding thus rather to a valve intended primarily for L.F. amplification. With 120 volts H.T. and the ample grid bias denoted by the curves of 9 volts, the valves proved able to handle really powerful signals, and gave excellent loud-speaking on the local transmission when used as first-stage L.F. valves. As a detector the low amplification factor was against the valve, though it oscillated with extreme ease. As a high-frequency amplifier the performance was not striking, much positive grid bias being needed for stability. The grid-current curve showed a decided current below zero grid volts; accordingly an unusually high grid-leak is required, as experiment confirmed, whilst the valve would operate smoothly as a detector without a grid-leak at all. In general, this type can be recommended for L.F. amplification, with proper H.T. and ample grid-bias, when there is a fair amount of signal energy to be handled, and under proper conditions (60 volts H.T. and a high grid-leak value) as an emergency detector.



Professor Julian Huxley, who is broadcasting a series of scientific lectures from the London Station.

Robinson's disclosures in yesterday's *Wireless Weekly*. The satisfaction I feel at the proved accuracy of my wavemeter is tempered by annoyance at what is either culpable negligence, or deliberate deceit on the part of the British Broadcasting Company. That the world's best broadcasting service

them when all five valves are in circuit.

Several of my friends have been persuaded by my good results to make up similar sets. Wishing you every success.—Yours faithfully,

R. B. WEST.

London, S.W.

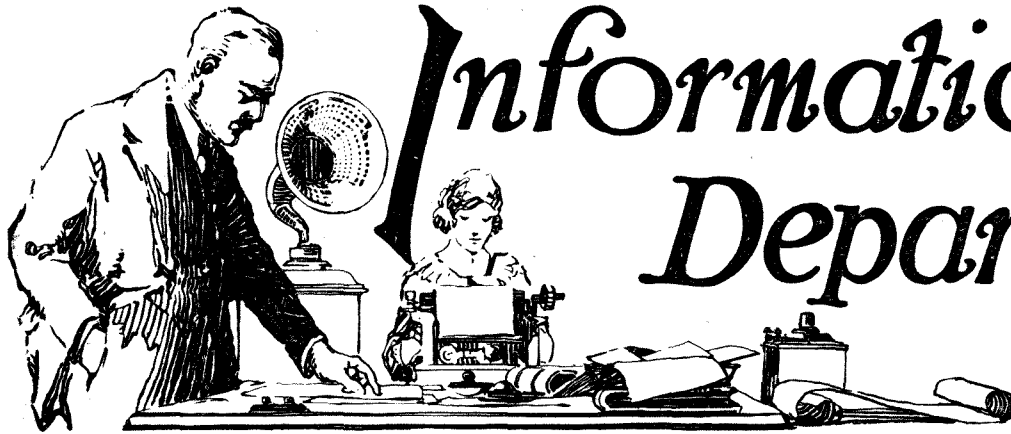

Information Department.

G. O. S. (NEWCASTLE-ON-TYNE) has submitted a wiring diagram of a 3-valve receiver, with one high-frequency stage stabilised by the neutrodyne method. He states that when he connects the high-tension supply to the high frequency valve, a flash is obtained.

Examination of our correspondent's wiring diagram at once showed the cause of his trouble. The grid condenser, connected between the plate of the first valve and the grid of the second was of a type in which the grid-leak clips were arranged so that the grid-leak was connected in parallel with the condenser. Instead of arranging that the grid-leak was inserted only into the clip on the side of the condenser which was connected

to the grid of the detector valve, the leak was placed in both clips, so that it was in parallel with the grid condenser, and the clip which was connected to the plate of the first valve was also taken directly to L.T.+ This, of course, resulted in short-circuiting the high-tension battery through the anode winding of the neutrodyne unit.

To rectify the fault the lead from the clip of the grid-condenser to L.T.+ should be removed, one end of the leak should be inserted into the other clip (connected to the grid of the detector valve) and its free end should be joined to low-tension positive. This latter connection should be effected by means of a further clip into which the end of the leak should be gripped and

not by soldering directly on to the metal end cap, since the heat of the iron is likely to impair the efficiency of the component.

G.S.P. (HOBART, TASMANIA) wishes to construct a 3-valve receiver, using a loose-coupled circuit, with reaction on to the secondary, a valve detector and two stages of transformer-coupled low frequency amplification. He states that he has a number of plugs and jacks which he wishes to utilise, and encloses sketches of these.

From our correspondent's sketches of his jacks we find he possesses a "single closed" jack, a "single filament" jack and two "double filament" jacks. The three latter will be suitable for use in the circuit requested.

"I built it after business hours in less than a week. It gets Rome and 30 other Stations on the Loud Speaker."

The amateur who sent us that report is only one of hundreds who have found in the Bowyer-Lowe Super Heterodyne a powerful receiver which is easy to build and use. Its range and selectivity astonish listeners. Its purity of reception is remarkable. When it is heard in operation, with only a frame aerial, even hardened wireless fans are surprised at its quality,

You can build this set quickly and easily. The Constructor's Kit now offered, contains the principal components required, with Baseboard, Drilled and Engraved Panels, Wiring Diagram, Blueprints, Progressive Assembly Photographs, and fully explanatory book of instructions.

This Kit is a Bowyer-Lowe Product. Every component is guaranteed, every one comes to you after an exhaustive test for efficiency. Building with these parts you are certain that your Super Heterodyne will be as efficient a receiver as science can make it. Moreover, if you need any special help or advice, the free service of our expert radio engineers is at your disposal.

Winter is approaching. You want to hear France, Belgium, Italy, Spain, as well as English Broadcasting. In a week you can be listening to almost any station in Europe. Make the Bowyer-Lowe Super Het. It is a set of which you will be proud. Start building at once. Order this Kit to-day.

Constructor's Kit for making the BOWYER-LOWE SEVEN VALVE SUPER-HETERODYNE £10

Bowyer-Lowe Co., Ltd., Radio Works, Letchworth.



The Kit Contains

Baseboard, Front Panel, Valve Panel, and Terminal Panels, drilled, polished and engraved; complete set of Bowyer-Lowe Super-Het. Transformers; Model II Oscillator Coupler, Square Law and Vernier Condensers, Anti-Capacity Valve Holders, the principal components for Super Het. building; together with blueprints of panel and wiring, progressive assembly Photographs and book of instructions.

£10 In box

ORDER TO-DAY DIRECT or FROM YOUR DEALER

The required circuit is given in Fig. 1. From this diagram it will be seen that the tuning arrangements are quite normal, parallel tuning being indicated for the aerial circuit in which a suitable value for C_1 will be $.0005 \mu F$. The coils will, of course, be determined by the wavelength range it is desired to cover. L_2 forms the secondary circuit, and for C_2 we would suggest a value of $.0003 \mu F$. Leaky grid condenser rectification is used, the normal values of $.0003 \mu F$ and 2 megohms being suitable. L_3 is the reaction coil. The aerial, secondary and reaction coils will, of course, be mounted in a three-coil holder.

Dealing with the remainder of the circuit it will be seen that two double filament jacks and one single filament jack have been used. The connections to these look somewhat complicated, but actually in practice the wiring is usually fairly simple, and short leads may be obtained if the components are suitably spaced. Reference to the diagram will show that when the telephones are plugged into the single filament jack all the valves are lit and brought into circuit, provided the filament rheostats are suitably adjusted. With the 'phones in the second double filament jack, the last valve is automatically switched off, the 'phones placed in the plate circuit of the second valve and the first two valves only used. With the plug in the first double filament jack the filaments of the last two valves are extinguished and the 'phones placed in the plate circuit of

the detector valve in place of the primary of the first L.F. transformer. The connections to C_4 , the by-pass condenser, should be noted, these

separate grid biasing batteries to the last two valves have been indicated so that varying types of valves may be used to their full advantage.

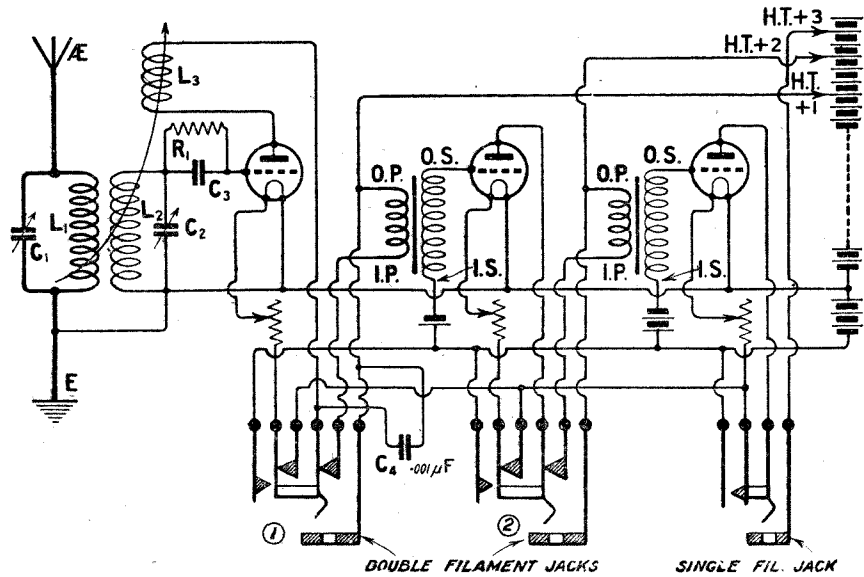
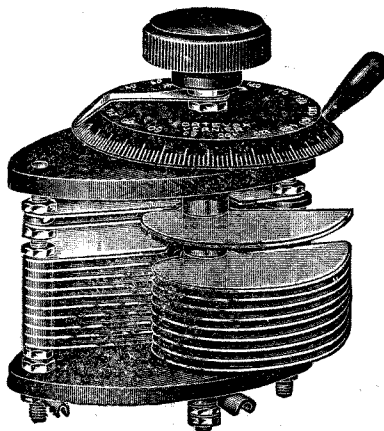

Fig. 1.—A straight 3-valve circuit consisting of a detector valve and two note magnifiers, in which jacks are incorporated to enable one, two or three valves to be used.

being arranged so that this condenser is in parallel with either the telephones or the primary of the first L.F. transformer according to whether one or more valves are being used. Separate high-tension tapings and

If desired, a common value of high tension may be applied to all three valves by joining H.T. +1, +2 and +3 together, but this practice is not to be advised where a considerable amount of power is to be handled,



If you fit a



Component

you get RELIABLE and EFFICIENT working, an ORIGINAL DESIGN giving you the "Something Different," and Skilled Workmanship with High Class Finish. Look, for example, at the FORTEVOX SQUARE LAW VARIABLE CONDENSER

This NEW DESIGN

is the only Condenser giving READINGS on both Main Condenser and Vernier. Full Instructions and Recording Charts with each instrument. One Hole Fixing.

Note this Season's Revised Prices

	Plain s. d.	Vernier s. d.
.001	13 9 each	17 3 each
.00075	13 0 "	16 6 "
.0005	10 6 "	14 0 "
.0003	9 0 "	12 6 "
.0002	8 6 "	12 0 "

Postage 5d.

For the Discriminating Buyer :

"We cannot recall having seen a better finished article."

THE BRITISH TRADE JOURNAL.

NOTE. ON SALE IN OCTOBER THE NEW "FORTEVOX" VARIABLE GRID LEAK

An ingenious and entirely original Design. Beautifully made. Contains NO cardboard, paper, discs, or fibre.

RETAINS CONSISTENT & PERFECT VARIATION.

Stocked by all reputable dealers, or obtainable direct from :

FRASER & GLASS, Assembly Works, Middle Lane, Hornsey, LONDON, N.8. Phone, Mountview 2225. Scottish Agents: KEITH & IRWIN, 35, Robertson Street, GLASGOW.

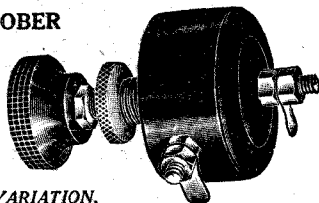

For making all Wireless Connections use the

Quality RADIO ELECTRIC SOLDERING SET.

Works from any wireless accumulator.

Complete, as illustrated, with full instructions.

5/6

Postage 3d.

No gas fire or lamp needed. Always ready, no waste; a joint is made in a few seconds. The soldering bit being of carbon, it requires no cleaning or tinning.

If your dealer cannot supply, we send post free if you mention his name and address.

GOSWELL ENGINEERING CO., LTD.,

95/8, WHITE LION STREET, LONDON, N.1.

Liberal Trade Terms.

LIST FREE.

'Phone: North 3051.

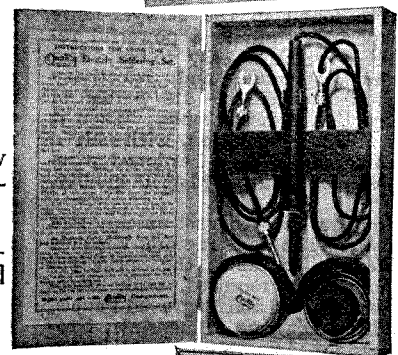

since a power valve, taking a higher value of high tension than the other valves, will be found advantageous in the last stage. Similarly the first L.F. valve will probably require a higher value of anode supply than the detector for most satisfactory working.

Shunt condensers across the high-tension tappings are also to be advised, and these should be connected between H.T. negative and H.T. +1, 2 and 3 respectively. Suitable values would be 1 or 2 μ F. These have been omitted from the diagram for the sake of simplicity.

M.A. (CHELMSFORD) asks what is meant by "spacing" and "marking" waves in wireless telegraphy.

When an arc is employed for telegraphic transmission it cannot be stopped and started in a very short space of time, and it has, therefore, to be continuously maintained in operation during the whole of the time in which a message is transmitted. The arc is therefore arranged to oscillate at a certain wavelength whilst the key is up and to radiate at a different wavelength when the key is depressed. This is effected by making the key operate a magnetic relay which short circuits a part of the aerial tuning inductance. Two waves are thus radiated by the arc transmitter, one when the transmitting key is up, and a shorter wave when the key is depressed. The first-mentioned wave is known as the "spacing" wave and the other as the "marking" wave.

F. E. (POOLE) wishes to employ a power valve in the note magnifying stage of his All-Concert de Luxe receiver and asks us what alterations will be necessary in the wiring.

To use a power valve to full advantage our correspondent will have to make but two slight alterations to the wiring of his receiver, in order that this valve shall receive a higher value of high-tension than the H.F. and detector valves and also grid bias.

If reference is made to the wiring blue print enclosed in Radio Press Envelope No. 4, a short lead will be seen connected from the right hand middle contact of the "telephone or loud-speaker" switch to a long lead joining the moving plates of the .00025 μ F condenser to high-tension positive. This short lead, which ends near the figures ".00025," should be removed and the middle right-hand contact of the switch should then be connected to a further terminal which will be used for the high-tension positive terminal for the last valve. The 2 μ F condenser at present connected across the high-tension supply to all valves, will now be across the supply to the high-frequency and detector valves only. It is therefore advisable to connect a further 2 μ F condenser between H.T. negative and the new high-tension positive terminal.

In order to insert a grid-biasing battery it will be necessary to remove the lead from the IS terminal of the L.F. transformer to L.T. negative and to bring a connection out from IS to a further terminal which will become

grid-bias negative. The positive end of the grid-bias battery can be connected directly to the L.T. negative terminal which will also still serve to take the lead from the negative side of the low-tension battery.

W. C. (WOKING) is experiencing trouble with his "Powerful 3-valve Receiver," described by Mr. Harris in the April issue of "The Wireless Construc.or." When first constructed the set functioned in a very satisfactory manner, but of late signal strength has tended to decrease, and finally, after the set had not been in use for a week, when again put into service, only a loud buzzing or howling noise could be obtained.

From these symptoms we would advise that the high-tension battery be renewed. When signal strength gradually falls off and finally the set buzzes or howls the cause is most often located in the high-tension battery, which has run down and developed a high internal resistance. This resistance is common to the plate circuits of all valves, and thus exerts coupling effects which cause the valves to oscillate at low frequency. The note of the howl will not be changed by tuning on the condensers, but adjustment of the filament resistances of the note magnifier valves will alter its volume. If the tendency towards buzzing is only slight the placing of large condensers, of 2 μ F or larger, across each high-tension tapping will effect a temporary cure.

Why is



REGISTERED TRADE MARK

THE HALL MARK OF "QUALITY" EBONITE?

Because it is made from finest rubber and sulphur

IT HAS
PROVED ITSELF

ITS POLISH
SPEAKS FOR ITSELF

All branded panels guaranteed free from surface leakage.

Write for full particulars and List B.

The BRITISH EBONITE Co., Ltd., HANWELL, LONDON, W.7

Rods, Tubes and Mouldings

S. SMITH & SONS (M.A) LTD

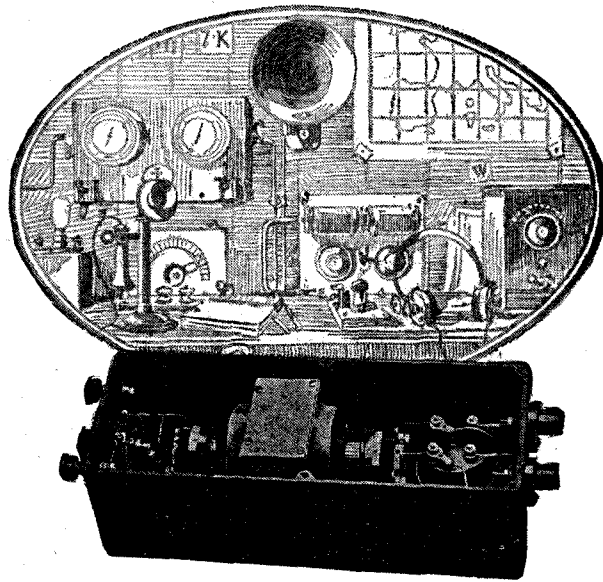

The M-L anode converter

THE M-L Converter is designed to replace H.T. Batteries.

It consists chiefly of a small motor-converter, being fed from an accumulator through a controlling rheostat. The high-tension current is generated by a specially wound motor of high efficiency, and supplied at the output terminals free from any ripple or hum due to the machine. This is secured by smoothing circuits, which are incorporated in the complete converter.

The M-L Anode converter is particularly recommended for use with Power Amplifying Valves or Transmitting Valves where a smooth and constant supply of H.T. current of the order of 20 to 30 milliamps is required. The current consumption of the motor is extremely low owing to its high efficiency and it is absolutely silent and free from vibration in working.

Single Voltage Types: Type B (6/120v. or 4/80v.) £11 5 0
 Type C (12/300v.) ... £13 10 0
 Type D (12/500v.) ... £18 0 0

Two Voltage Types: Type BX (6/120v. or 4/80v.) £12 15 0
 Type CX (12/300v.) ... £15 0 0

We shall be glad to send full particulars of all M-L Anode Converters and auxiliary apparatus on request.



S. SMITH & SONS (M.A) LTD.
 179-185 Great Portland Street, London, W.1

Telephone: Langham 2323

E.P.S.7.

Still the Best way of building ones set

Radio Press Envelopes show the novice the simplest and safest way to construct his set. The possibility of error has been eliminated by the careful and complete instructions contained in each envelope.

Their range covers every kind of receiver from crystal to multi-valve, and all are guaranteed to give efficient results if the instructions are carried out.

RADIO PRESS ENVELOPES

No.	Price.	Post Free.
1	1/6	1/9
How to Build an ST100 Receiver ... By John Scott-Taggart, F.Inst.P., A.M.I.E.E.		
2	2/6	2/9
How to Build the "Family" 4-Valve Receiver ... By Percy W. Harris, M.I.R.E.		
3	2/6	2/9
How to Build the "Simplicity" 3-Valve Set ... By G. P. Kendall, B.Sc.		
4	2/6	2/9
How to Build the All-Concert de Luxe Receiver ... By Percy W. Harris, M.I.R.E.		
5	2/6	2/9
How to Build the Omni Receiver ... By John Scott-Taggart, F.Inst.P., A.M.I.E.E.		
6	1/6	1/9
How to Build the ABC Wave Trap ... By G. P. Kendall, B.Sc.		
7	1/6	1/9
How to Build a 2-Valve Amplifier de Luxe ... By Herbert K. Simpson.		
8	1/6	1/9
How to Make a 1-Valve Reflex Receiver ... By Herbert K. Simpson.		
9	1/6	1/9
How to Build an Efficient Single-Valve Set ... By Herbert K. Simpson.		
10	2/6	2/9
The Twin-Valve Loud-speaker Receiver ... By John Scott-Taggart, F.Inst.P., A.M.I.E.E.		
11	1/6	1/9
An Adaptable Crystal Set ... By Percy W. Harris, M.I.R.E.		

All the above can be obtained from Wireless Dealers, Newsagents, Bookstalls—or direct from—Dept S.

For prompt and sure delivery when ordering direct please write your name in BLOCK LETTERS.

RADIO PRESS, LTD.,
 BUSH HOUSE, STRAND,
 LONDON, W.C.2.

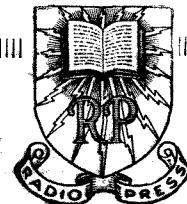

**2^D EVERY
TUESDAY
WEEKLY**



THE EDITOR:
PERCY W. HARRIS,
M.I.R.E.

TECHNICAL DIRECTOR:
JOHN SCOTT-TAGGART,
F.Inst.P., A.M.I.E.E.

RESEARCH EDITOR:
Major JAMES ROBINSON,
D.Sc., Ph.D., F.Inst.P.

“WIRELESS,” the great new Radio Press weekly, has exceeded all expectations in demand. Its light varied contents have gained the approval of thousands of Radio enthusiasts, hitherto without an appropriate weekly.

“WIRELESS” appeals to everybody. You cannot help liking it. Start with No. 3 TO-DAY, it contains many striking features.

**ARTICLES YOU MUST READ IN
No. 3:**

LICENCE PROFITEERING BY THE POST OFFICE. *By Lt. Commander Kenworthy, R.N., M.P.*

HOW TO GET THE MOST FROM REACTION. *By Major James Robinson, D.Sc., Ph.D., F.Inst.P.*

HOW AMERICA PAYS FOR BROADCASTING. *By Percy W. Harris, M.I.R.E.*

HOW TO MAKE A VERNIER CRYSTAL SET.

HOW TO MAKE a SENSITIVE ONE-VALVE SET. *By Stanley G. Rattee, M.I.R.E.*

And numerous practical and constructional notes.

**Buy your
copy TO-DAY**

Obtainable at all Bookstalls and Newsagents.
If any difficulty send 13/- for yearly subscription to Radio Press, Ltd., Bush House, Strand, W.C.2.



There is a Sterling Receiver, Loud Speaker or Component for every radio purpose. There is no wider range of quality apparatus and prices in the country.

Brief particulars of the illustrations, showing a representative range of the famous Sterling products

Receiving Sets

STERLING CRYSTAL RECEIVER. With semi-automatic detector. Wave range 300-1,600 metres £3:3:0
FOUR-VALVE RECEIVER. A long range set, tunable from 40 to 5,000 metres. Less accessories and royalties - £28:15:0
"ANODION" TWO-VALVE RECEIVER. A long range instrument of exceptional merit. Less accessories and royalties - £8:0:0
 The "Anodion" Range also includes one, three and four valve types.
TWO-VALVE POWER AMPLIFIER. Specially designed to give great volume without distortion. In two types - £9:15:0 & £9:5:0
"REGINA" FOUR-VALVE FLOOR CABINET RECEIVER. A beautiful self-contained instrument with a "Primax" Loud Speaker. Including accessories but less royalties - £63

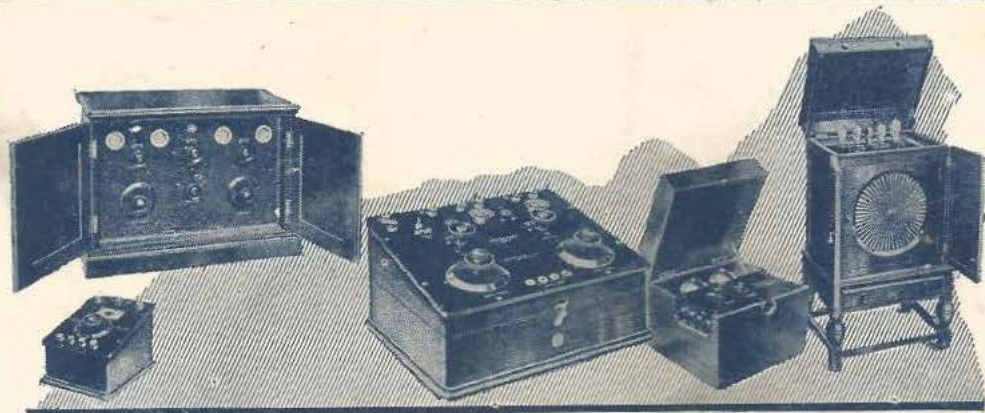

Loud Speakers

"DINKIE." "The Little Fellow with the Loud Voice" - 30/-
"MELLOVOX." A supremely perfect hornless model at a popular price - 48/-
"BABY." "The most popular entertainer in the world" - 50/-
"PRIMAX." "The very soul of music." An exceptionally handsome hornless model - £6:0:0
"AUDIVOX II." The all-purpose instrument for home or public use - £4:10:0

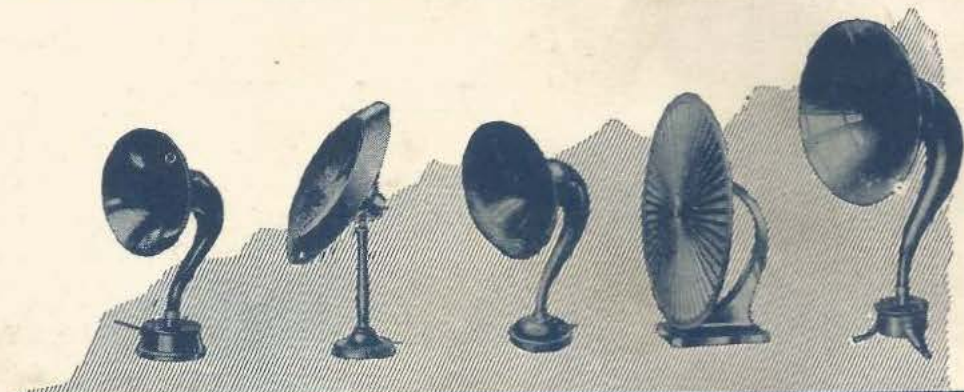

Components

"NON-PONG" VALVE HOLDERS. Obviate micropenic noise; and lengthen the life of valves - 4/3
 Valve Holder Adapter - 5/-
AERIAL COUPLING UNITS. Specially constructed for short wave reception. 40-150 metres - 5/6
 135-275 metres - 9/-
REACTION UNITS. Provide an efficient and convenient method of employing reaction. In eight types, covering wave lengths from 40 to 5,000 metres - Each 12/6
SQUARE LAW VARIABLE CONDENSERS. With and without vernier adjustment, all geared; double and triple; and balanced types. Prices on application.
INTERVAL TRANSFORMERS. For distortionless low frequency amplification. Unmounted - 20/-
 Mounted - 25/-
HIGH GRADE VARIOMETER. Wave-length range when used for aerial tuning, 250 to 2,725 metres 21/-
"LILLIPUT" HEADPHONES. A veritable masterpiece of headphone efficiency - Per Pair 20/-

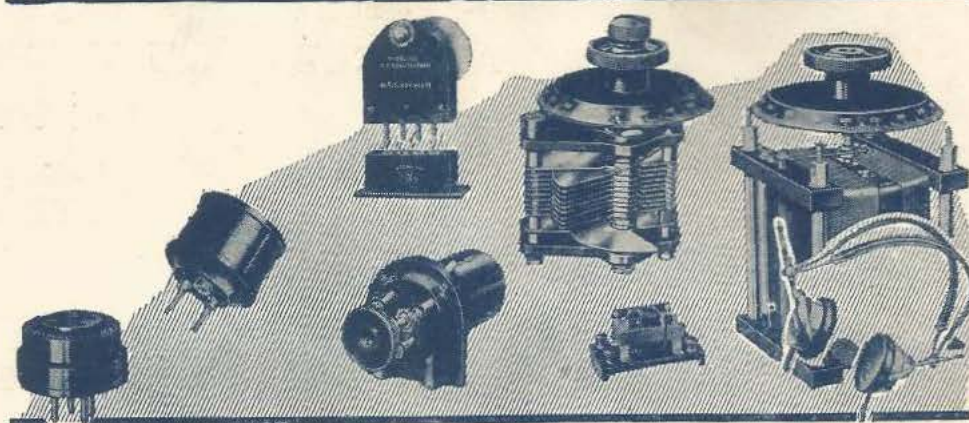

Announcement of THE MARCONIPHONE COMPANY, LIMITED
 210-212, TOTTENHAM COURT ROAD, LONDON, W.1

Sole Agents for STERLING TELEPHONE & ELECTRIC CO., LTD.

At your radio dealers